









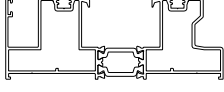

SL48T

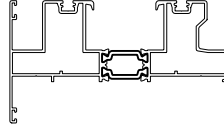
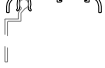
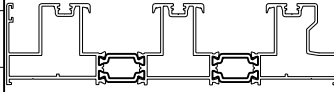
YALITIMLI SÖRME SİSTEMİ
THERMAL SLIDING SYSTEM

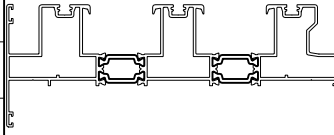
ASISTAL

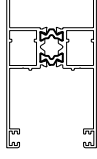
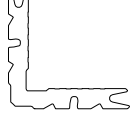
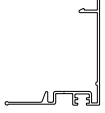
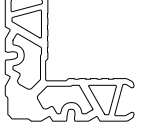
PROFİL ve AKSESUAR LİSTELERİ
PROFILE & ACCESSORIES LIST

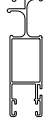
PROFİL LİSTESİ - PROFILE LISTS

SL48T 01			12-52		
İKİLİ KASA PROFİLİ FRAME PROFILE	AĞIRLIK / Weight 1,899 kg/mt		PERVAZ PROFİLİ BORDER PROFILE	AĞIRLIK / Weight 0,279kg/mt	
SL48T 02			12-52		
İKİLİ KASA PROFİLİ FRAME PROFILE	AĞIRLIK / Weight 1,994 kg/mt		PERVAZ PROFİLİ BORDER PROFILE	AĞIRLIK / Weight 0,279kg/mt	
SL48T 03			12-53		
	AĞIRLIK / Weight 2,884 kg/mt		PERVAZ PROFİLİ BORDER PROFILE	AĞIRLIK / Weight 0,177kg/mt	
SL48T 04			LS70 61		
	AĞIRLIK / Weight 2,979 kg/mt		DAMLALIK PROFİLİ COVER PROFILE	AĞIRLIK / Weight 0,231 kg/mt	
SL48T 11			10-010106-00		
	AĞIRLIK / Weight 1,576kg/mt		KÖŞE TAKOZU-10,6 mm CORNER JOINT	AĞIRLIK / Weight 2,653 kg/mt	
SL48T 41			10-010225-00		
KENET PROFİLİ CENTRAL LOCKING PROFILE	AĞIRLIK / Weight 0,501 kg/mt		KÖŞE TAKOZU-22,5 mm CORNER JOINT	AĞIRLIK / Weight 3,56 kg/mt	
SL48T 42					
ADAPTOR PROFİLİ ADAPTER PROFILE	AĞIRLIK / Weight 0,653 kg/mt				
15-306317-11					
SİNEKLİK KANAT PROFİLİ FLYSCREEN SASH PROFILE	AĞIRLIK / Weight 0,561 kg/mt				
SL38T 61					
SİNEKLİK RAY PROFİLİ FLYSCREEN RAIL PROFILE	AĞIRLIK / Weight 0,185 kg/mt				
SL32 43					
ADAPTÖR PROFİLİ ADAPTER PROFILE	AĞIRLIK / Weight 0,235 kg/mt				

AKSESUAR LİSTESİ - ACCESSORIES LIST

EP1-01			SL38T-PLU		
DİŞ CAM FİTİLİ - 2,5 mm OUTER GLAZING GASKET	KOLİ MİKTARI/Package 240 mt / 15 kg		KASA YALITIM PVC FRAME ISOLATION GASKET	KOLİ MİKTARI/Package 6 mt/adet	
EP2-01			ASI-SR 48T		
İÇ CAM FİTİLİ - 3 mm INNER GLAZING GASKET	KOLİ MİKTARI/Package 440 mt / 15 kg		AYARLI ÇİFTLİ RULMAN (U TİPİ RAY İÇİN) DOUBLE SLIDING ROLLER FOR RAIL TYPE - U	KOLİ MİKTARI/Package Adet / Piece	
EP2-02					
İÇ CAM FİTİLİ - 4 mm INNER GLAZING GASKET	KOLİ MİKTARI/Package 300 mt / 15 kg				
EP2-03					
İÇ CAM FİTİLİ - 5 mm INNER GLAZING GASKET	KOLİ MİKTARI/Package 250 mt / 15 kg				
KC 02					
CAM FİTİLİ - 2 mm GLAZING GASKET	KOLİ MİKTARI/Package 100 mt / 4,5 kg				
EP70-02					
KASA KANAL FİTİLİ FRAME GASKET	KOLİ MİKTARI/Package				
ASI-5025					
SİNEKLİK FİTİLİ FLYSCREEN GASKET	KOLİ MİKTARI/Package 100 mt				
KF 67-550					
FİRÇA FİTİL - 5,5 mm BRUSH GASKET	KOLİ MİKTARI/Package 1400 mt				
KF 67-700					
FİRÇA FİTİL - 7 mm BRUSH GASKET	KOLİ MİKTARI/Package 1200 mt				
SL38T-SFP 01					
ALT-ÜST HAVA KESİCİ EPDM BOTTOM-TOP WEATHER PROTECTOR	KOLİ MİKTARI/Package Adet / Piece				

SL48T

YALITIMLI SÜRME SİSTEM
THERMAL SLIDING SYSTEM

ASISTAL

PROFİL DETAYLARI
PROFILE DETAILS

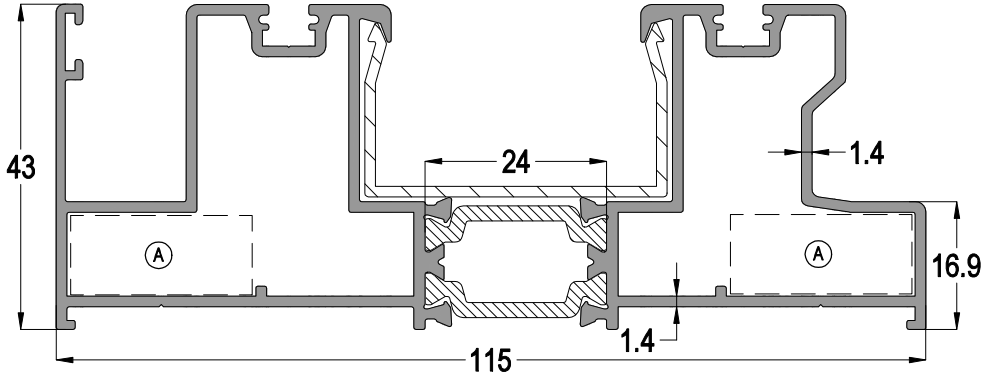

SL48T 01

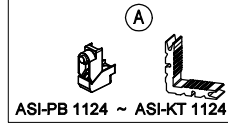

AĞIRLIK / Weight

1,899 kg/mt

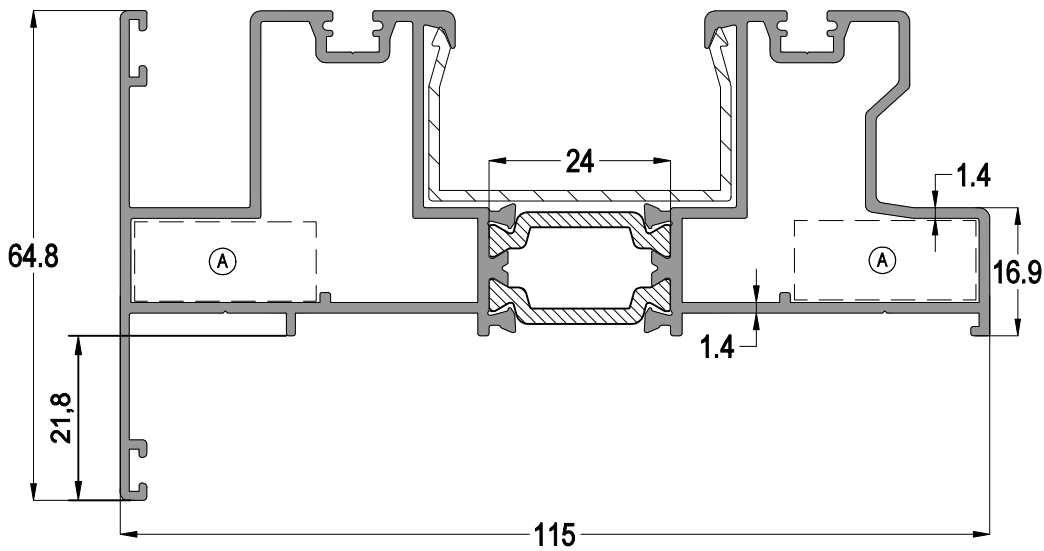

SL48T 02



AĞIRLIK / Weight

1,994 kg/mt

SL48T

YALITIMLI SÜRME SİSTEMİ
THERMAL SLIDING SYSTEM

ASISTAL

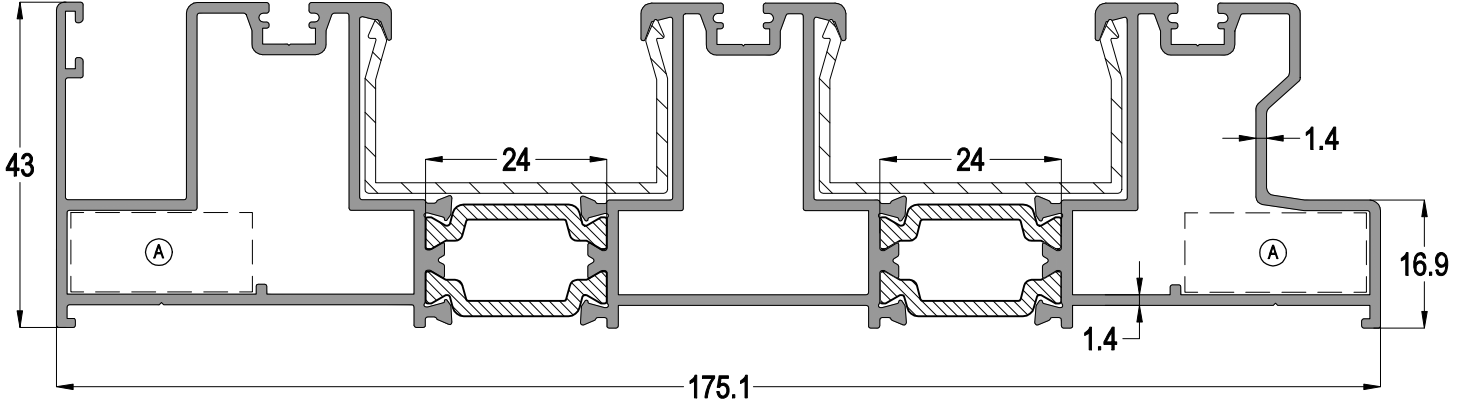

SL48T 03

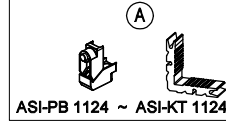

AĞIRLIK / Weight

2,884 kg/mt

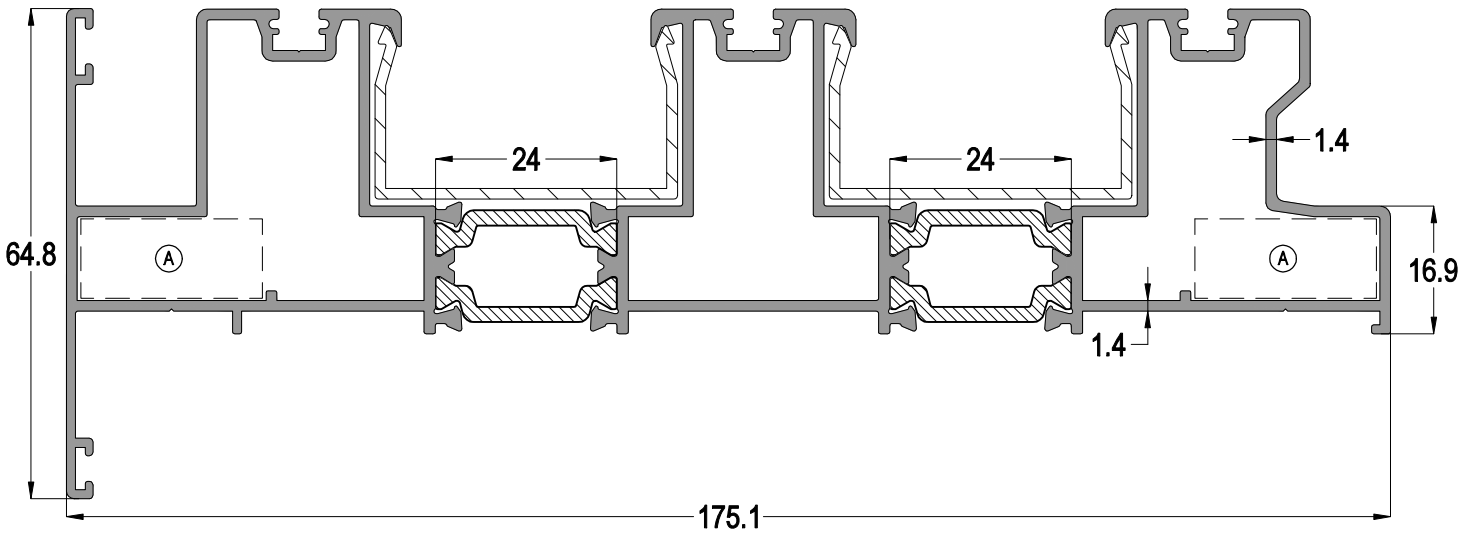

SL48T 04



AĞIRLIK / Weight

2,979 kg/mt

Profil ağırlıklarımız teorik olup; teslim anındaki tartımız geçerlidir.

SL48T

YALITIMLI SÜRME SİSTEMİ
THERMAL SLIDING SYSTEM

ASISTAL

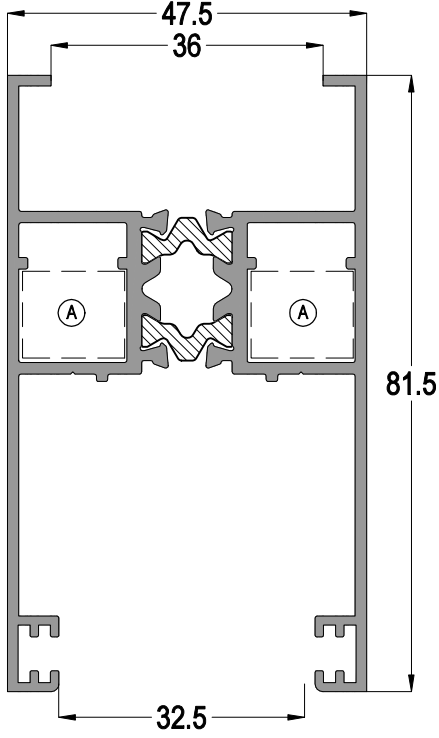

SL48T 11	
	AĞIRLIK / Weight
ASI-KT 1214	1,576 kg/mt

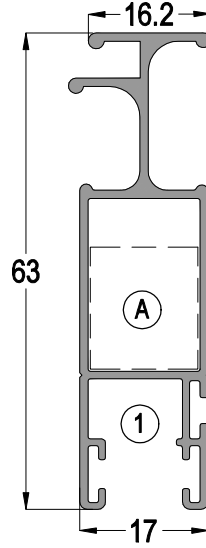

15-306317-11	
	AĞIRLIK / Weight
ASI-BZ 5007	0,561 kg/mt
	
ASI-BZ 5060	

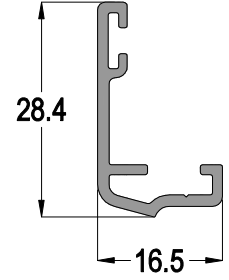

LS70 61	
	AĞIRLIK / Weight
	0,231 kg/mt

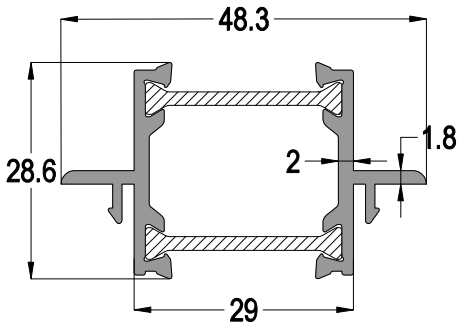

SL48T 42	
	AĞIRLIK / Weight
	0,653 kg/mt

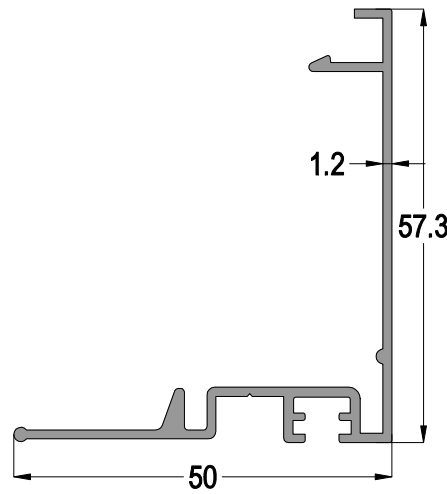

SL48T 42	
	AĞIRLIK / Weight
	0,501 kg/mt

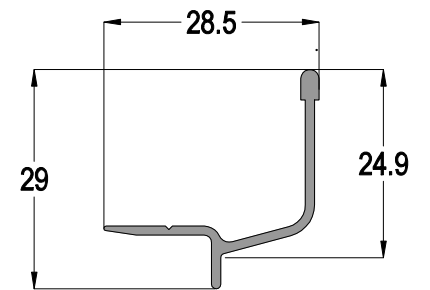

SL38T 61	
	AĞIRLIK / Weight
	0,185 kg/mt

SL48T

YALITIMLI SÖRME SİSTEM
THERMAL SLIDING SYSTE

ASISTAL

SİSTEM DETAYLARI
SYSTEM DETAILS

SL48T

YALITIMLI SÜRME SİSTEMİ
THERMAL SLIDING SYSTEM

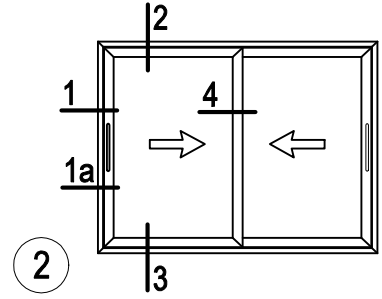

1

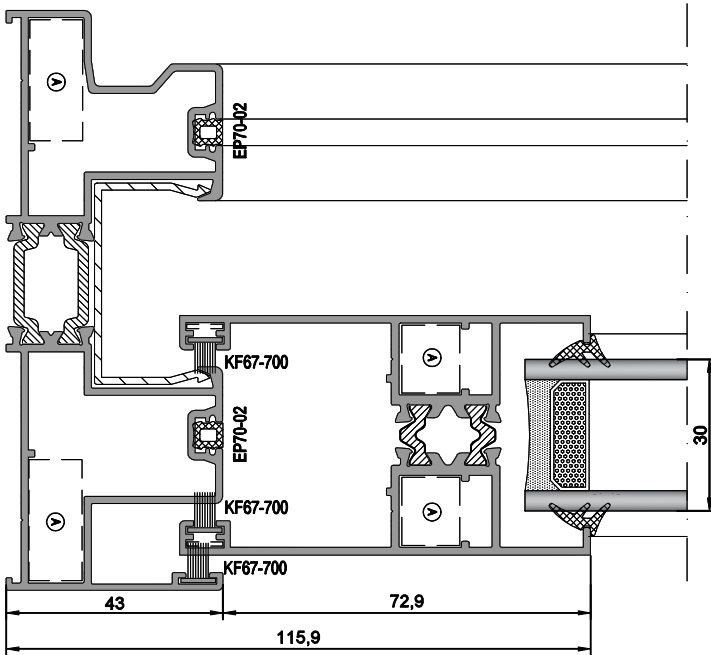

1a

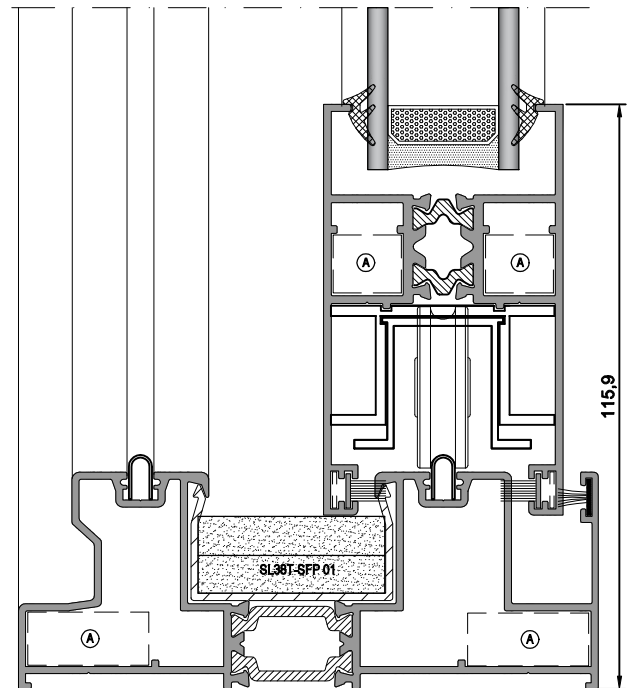
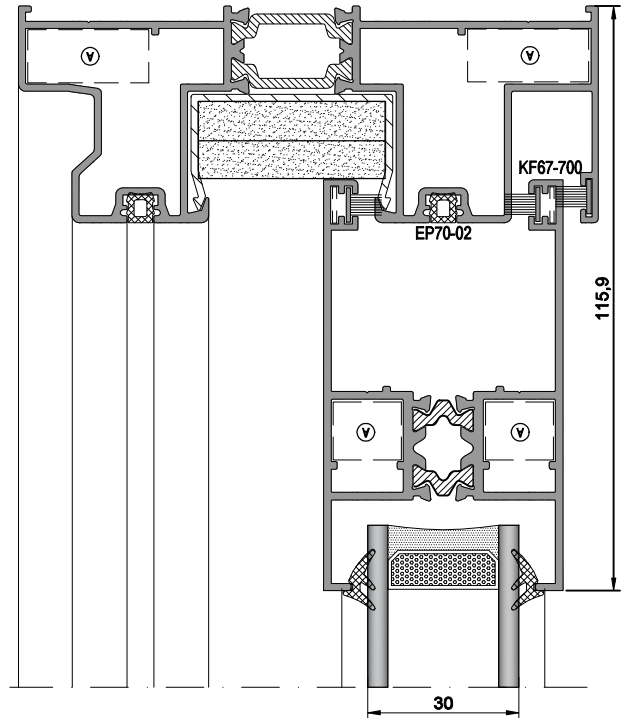
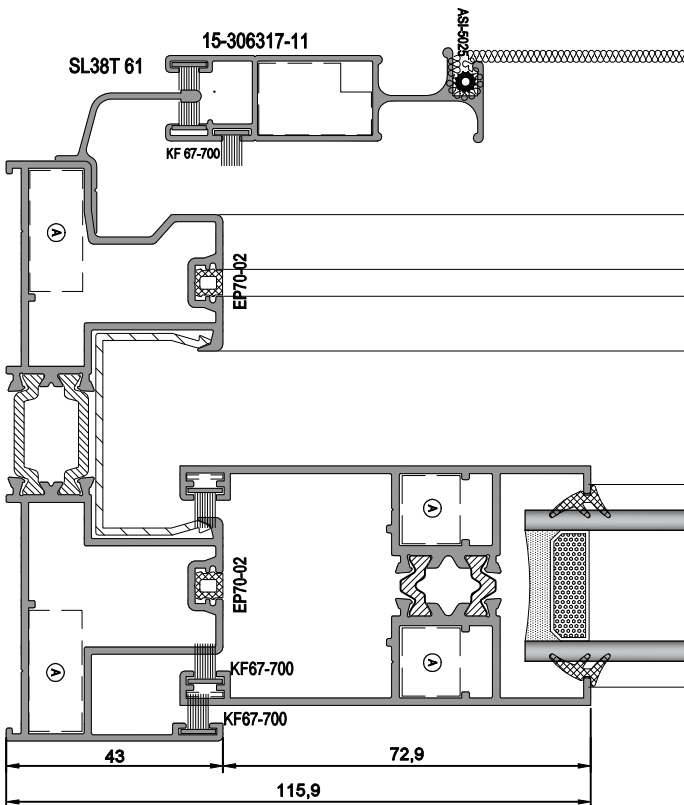

3

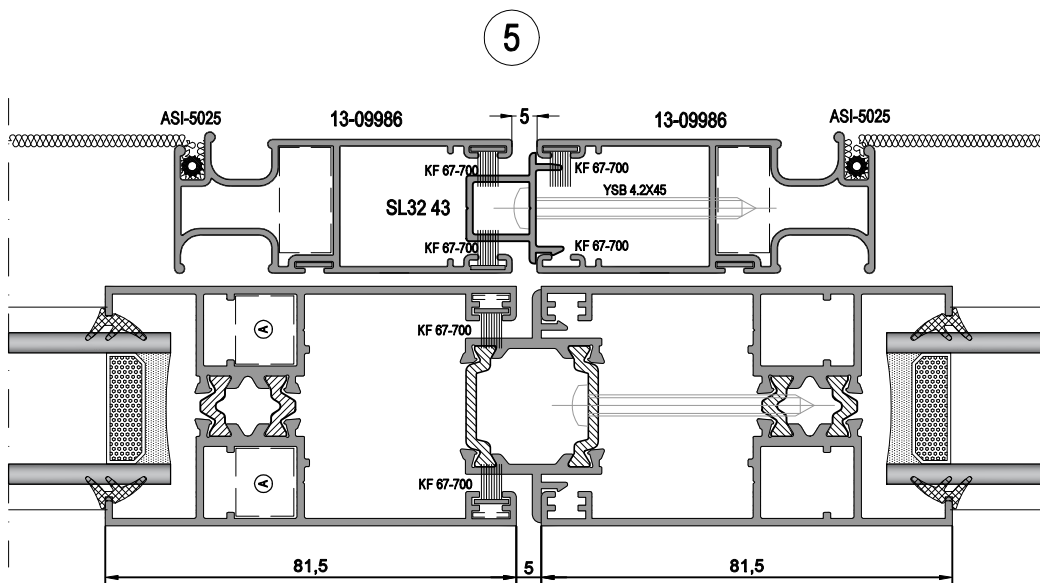
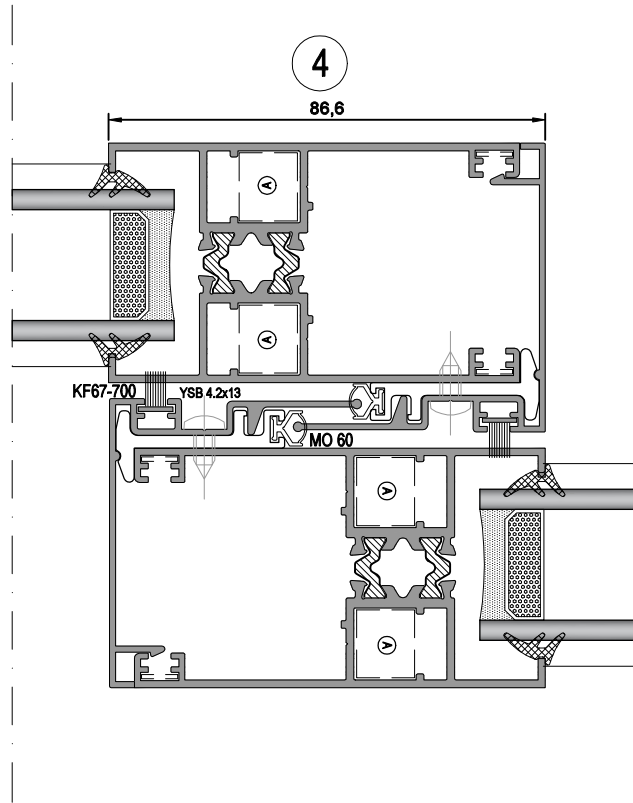
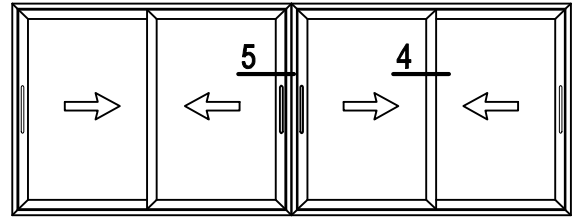

2 HAREKETLİ KANAT KESİM ÖLÇÜLERİ 45°x45° Bağlantı

2 SLIDING SASHES CUTTING SIZE 45°x45° Connections

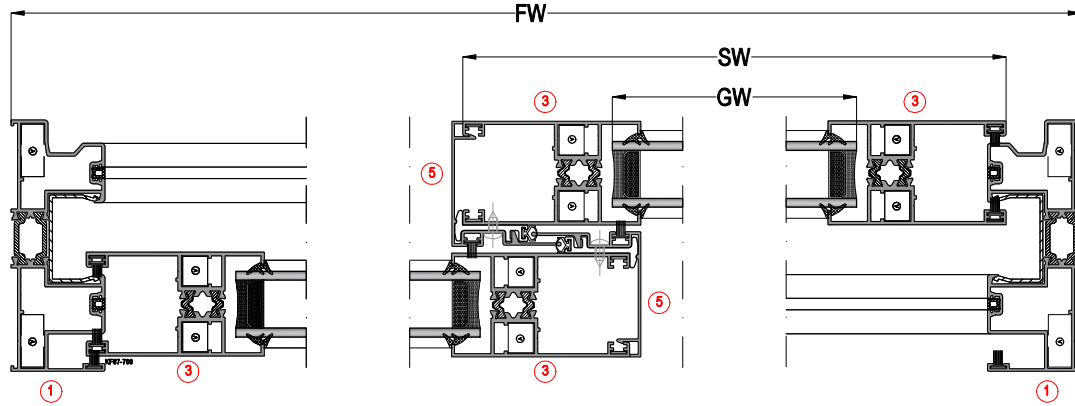
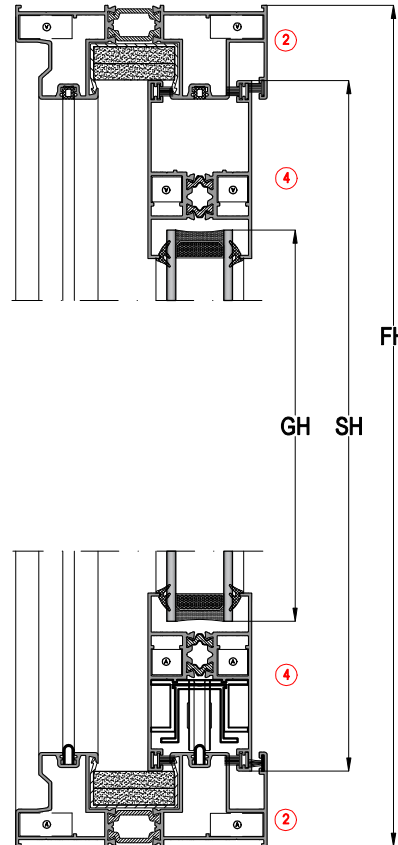
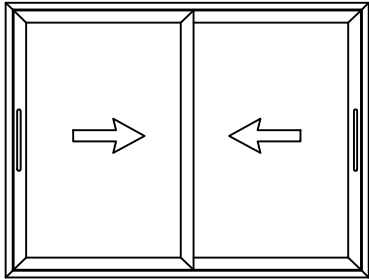
NORMAL SÜRME SİSTEM
NORMAL SLIDING SYSTEM

İSPANYOLET KİLİTLEME İÇİN AKSESUARLAR / ACCESSORIES FOR MULTI POINT LOCKING

MİKTAR / Unit	KOD / Code	PROFİL ÇİZİMİ / Drawing	PROFİL TANIMI / Description	KESİM ÖLÇÜSÜ / Cutting Dimensions
2 Adet / Pcs	ASHSP 15.3		İSPANYOLET KİLİTLEME / Multi Point Lock	
6 Adet / Pcs	ASHSP K02		İSPANYOLET KİLİT KARŞILIĞI / Multi Point Strike	
2 Adet / Pcs	ASI-WH 002		İSPANYOLET KİLİTLEME KOL / Window Handle	
2 Adet / Pcs	SL28 44		İSPANYOLET KİLİTLEME KANAL PROFİLİ / Multi Lock Profile	
HAVUZLU KOL KULLANIM AKSESUARLAR / ACCESSORIES FOR EMBEDDED HANDLES				
2 Adet / Pcs	ASI-SH 007		HAVUZ KOL / Embedded Handle	
2 Takım / Set	ASI-SH 007K		HAVUZLU KOL KARŞILIK / Embedded Handle Strike	

PROFİLLER / PROFILES					
NO / Number	ADET / Unit	KOD / Code	PROFİL ÇİZİMİ / Drawing	PROFİL TANIMI / Description	KESİM ÖLÇÜSÜ / Cutting Dimensions
1	2	SL48T 01		DÜŞEY KASA PROFİLİ / Vertical Frame Profile	FH
2	2	SL48T 01		YATAY KASA PROFİLİ / Horizontal Frame Profile	FW
3	4	SL48T 11		DÜŞEY KANAT PROFİLİ / Vertical Sash Profile	SH=FW-68,9mm
4	4	SL48T 11		YATAY KANAT PROFİLİ / Horizontal Sash Profile	SW=(FW/2)+3,7mm
5	2	SL48T 41		KENET PROFİLİ / Central Locking Profile	SL48T 41=SH
	2			KENET PVC PROFİLİ / Central Locking PVC Profile	SH
	2	SL38T PLU		YATAY KASA KANAL PVC / Horizontal PVC Channel Profile	FW-35
	2	SL38T PLU		DÜŞEY KASA KANAL PVC / Vertical PVC Channel Profile	FH-35
	2	ASI-INR 01		ÇELİK RAY PROFİLİ / Steel Rail Profile	FW-75.1

FİTİLLER / GASKETS				
MİKTAR / Unit	KOD / Code	PROFİL ÇİZİMİ / Drawing	PROFİL TANIMI / Description	KESİM ÖLÇÜSÜ / Cutting Dimensions
mt.	EP2-01		CAM FİTİLİ / Glazing Gasket	(4xGW)+(4xGH)
mt.	EP70-02		KASA KANAL FİTİLİ / Frame Gasket	(4xFH)+(2xFW)
mt.	KF 67-650		FİRÇA FİTİL / Brush Gasket - 6,5mm	(4xSW)+(4xSH)+(2xSH)

AKSESUARLAR / ACCESSORIES				
4 Adet / Pcs	ASI-STP 03		KANAT STOPER / Sash Stopper	
4 Adet / Pcs	SL40T-KP01		KENET KAPAĞI ALT-ÜST / Interlock Profile Cap Top-Bottom	
2 Adet / Pcs	SFP 01		ALT-ÜST HAVA KESİCİ EPDM / Bottom-Top Weather Protector	
16 Adet / Pcs	ASI-PB 19		KÖŞE GÖNYESİ / Corner Alignment	
16 Adet / Pcs	ASI-PB 19.1		KÖŞE GÖNYESİ / Corner Alignment	
16 Adet / Pcs	10-010108-00		OZEL KOSE BAGLANTI / Corner Joint	
8 Adet / Pcs	10-010225-00		OZEL KOSE BAGLANTI / Corner Joint	
4 Adet / Pcs	ASI-SR 48T		AYARLI ÇİFTLİ RULMAN / Double Sliding Roller	
2 Adet / Pcs	ASI-WDC 01		YAĞMUR TAHLİYEKAPAĞI / WATER REJECT COVER	

CAM KESİM ÖLÇÜLERİ / GLASS CUTTING SIZES

KOD / Code	TANIMI / Description	KESİM ÖLÇÜSÜ / Cutting Dimensions
GW	CAM GENİŞLİK / Sash Glass Width	GW=SW-137mm
GH	CAM YÜKSEKLİK / Sash Glass Height	GW=SH-137mm

2 HAREKETLİ KANAT KESİM ÖLÇÜLERİ 45°x45° Bağlantı

2 SLIDING SASHES CUTTING SIZE 45°x45° Connections

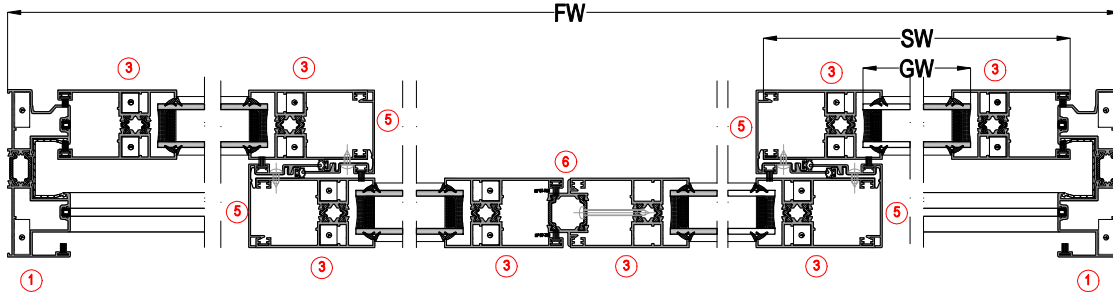
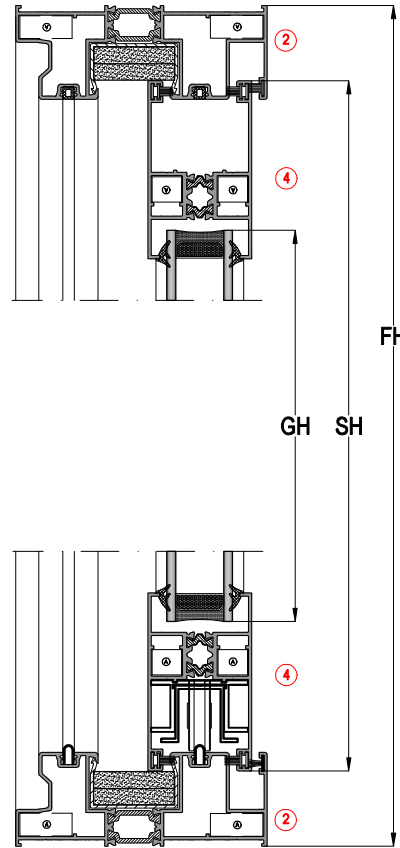
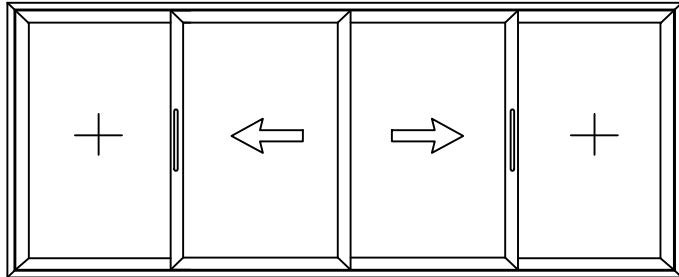
NORMAL SÜRME SİSTEM
NORMAL SLIDING SYSTEM

İSPANYOLET KİLİTLEME İÇİN AKSESUARLAR / ACCESSORIES FOR MULTI POINT LOCKING

MİKTAR / Unit	KOD / Code	PROFİL ÇİZİMİ / Drawing	PROFİL TANIMI / Description	KESİM ÖLÇÜSÜ / Cutting Dimensions
1 Adet / Pcs	ASHSP 15.3		İSPANYOLET KİLİTLEME / Multi Point Lock	
6 Adet / Pcs	ASHSP K02		İSPANYOLET KİLİT KARŞILIĞI / Multi Point Strike	
1 Adet / Pcs	ASI-WH 002		İSPANYOLET KİLİTLEME KOL / Window Handle	
1 Adet / Pcs	SL28 44		İSPANYOLET KİLİTLEME KANAL PROFİLİ / Multi Lock Profile	
HAVUZLU KOL KULLANIM AKSESUARLAR / ACCESSORIES FOR EMBEDDED HANDLES				
2 Adet / Pcs	ASI-SH 007		HAVUZ KOL / Embedded Handle	
2 Takım / Set	ASI-SH 007K		HAVUZLU KOL KARŞILIK / Embedded Handle Strike	

PROFİLLER / PROFILES					
NO / Number	ADET / Unit	KOD / Code	PROFİL ÇİZİMİ / Drawing	PROFİL TANIMI / Description	KESİM ÖLÇÜSÜ / Cutting Dimensions
1	2	SL48T 01		DÜŞEY KASA PROFİLİ / Vertical Frame Profile	FH
2	2	SL48T 01		YATAY KASA PROFİLİ / Horizontal Frame Profile	FW
3	8	SL48T 11		DÜŞEY KANAT PROFİLİ / Vertical Sash Profile	SH=FW-68,9mm
4	8	SL48T 11		YATAY KANAT PROFİLİ / Horizontal Sash Profile	SW=(FW/4)+19.7mm
5	4	SL48T 41		KENET PROFİLİ / Central Locking Profile	SL48T 41=SH
6	1	SL48T 42		ADAPTOR PROFİLİ / Adapter Profile	SL48T 41=SH
	4			KENET PVC PROFİL / Central Locking PVC Profile	SH
	2	SL38T PLU		YATAY KASA KANAL PVC / Horizontal PVC Channel Profile	FW-35
	2	SL38T PLU		DÜŞEY KASA KANAL PVC / Vertical PVC Channel Profile	FH-35
	2	ASI-INR 01		ÇELİK RAY PROFİLİ / Steel Rail Profile	FW-75.1

FİTİLLER / GASKETS				
MİKTAR / Unit	KOD / Code	PROFİL ÇİZİMİ / Drawing	PROFİL TANIMI / Description	KESİM ÖLÇÜSÜ / Cutting Dimensions
mt.	EP2-01		CAM FİTİLİ / Glazing Gasket	(8xGW)+(8xGH)
mt.	EP70-02		KASA KANAL FİTİLİ / Frame Gasket	(4xFH)+(2xFW)
mt.	KF 67-650		FİRÇA FİTİL / Brush Gasket - 6,5mm	(8xSW)+(8xSH)+(2xSH)

AKSESUARLAR / ACCESSORIES				
4 Adet / Pcs	ASI-STP 03		KANAT STOPER / Sash Stopper	
4 Adet / Pcs	SL40T-KP01		KENET KAPAĞI ALT-ÜST / Interlock Profile Cap Top-Bottom	
2 Adet / Pcs	SFP 01		ALT-ÜST HAVA KESİCİ EPDM / Bottom-Top Weather Protector	
16 Adet / Pcs	ASI-PB 19		KÖŞE GÖNYESİ / Corner Alignment	
16 Adet / Pcs	ASI-PB 19.1		KÖŞE GÖNYESİ / Corner Alignment	
16 Adet / Pcs	10-010108-00		OZEL KOSE BAGLANTI / Corner Joint	
8 Adet / Pcs	10-010225-00		OZEL KOSE BAGLANTI / Corner Joint	
4 Adet / Pcs	ASI-SR 48T		AYARLI ÇİFTLİ RULMAN / Double Sliding Roller	
2 Adet / Pcs	ASI-WDC 01		YAĞMUR TAHLİYEKAPAĞI / WATER REJECT COVER	

CAM KESİM ÖLÇÜLERİ / GLASS CUTTING SIZES

KOD / Code	TANIMI / Description	KESİM ÖLÇÜSÜ / Cutting Dimensions
GW	CAM GENİŞLİK / Sash Glass Width	GW=SW-137mm
GH	CAM YÜKSEKLİK / Sash Glass Height	GW=SW-137mm