

LS60

ISI YALITIMLI SÜRME SİSTEMİ INSULATED SLIDING SYSTEM

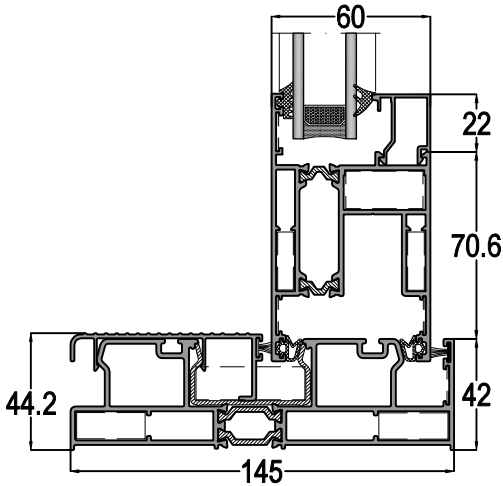

- İç bini, dış bini ve orta tozluk fitili sayesinde maksimum hava ve su performansı / Inner gasket, outer gasket and gasket for open joint maximum air and water performance
- Diğer sistemler ile de uyumlu ortak pres köşe ve pimli bağlantı kullanımı / Use of common press corners and pin connections compatible with other systems
- Duvar içine sürülebilir, tek raylı kasa üzerinde hareketli kanat uygulama seçeneği / Option to use movable sash on single rail frame that can slide into the wall.
- Kanat ve kanada özel köşe birleşim detayı / Sash - corner joint detail specific to the sash
- İlave takviye profili ile güçlendirilmiş kanat seçeneği / Option to use sash reinforced with additional profile.
- 300kg ve 150kg taşıma kapasitesli mekanizmaya uygun kanat seçenekleri / Sash options suitable for mechanisms with 300kg and 150kg carrying capacity.
- Çelik ray kullanımı / Use of steel rail

KASA GENİŞLİĞİ : 69 mm - 136 mm - 145 mm - 167 mm
176 mm - 221 mm - 252 mm

Frame width

KANAT GENİŞLİĞİ : 60 mm

Sash width

SİSTEM ET KALINLIĞI : 1,4 mm - 1,8 mm

System wall tickness

ISI BARIYERİ : Kasa / Frame : 24 mm

Insulation barrier Kanat / Sash : 14.8 mm

CAM KALINLIĞI : 10 mm - 46 mm

Glass thickness





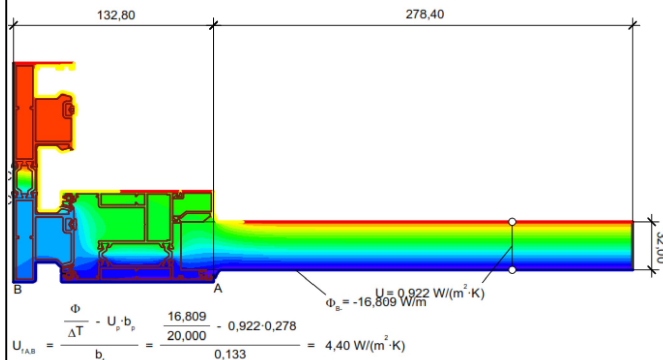

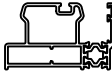

AÇILIM TİPLERİ : Tek hareketli kanat, İki hareketli kanat,
Dört hareketli kanat, Altı hareketli kanat

Opening types : Monorail, Two moving sashes, Four moving sashes, six moving sashes

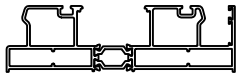
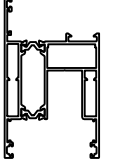

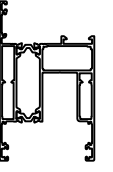
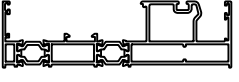
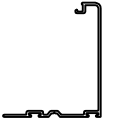
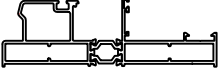
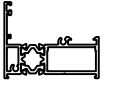
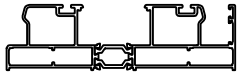
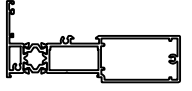
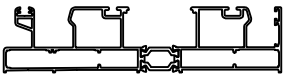

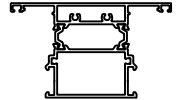

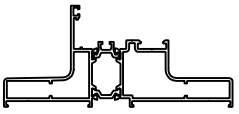
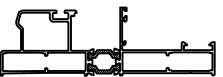
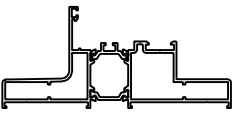











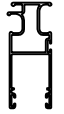

PROFİL VE AKSESUAR LİSTELERİ
PROFILE & ACCESSORIES LIST















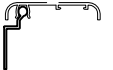

PROFİL LİSTESİ - PROFILES LIST

LS60 01			LS60 108F		
KASA PROFİLİ FRAME PROFILE	AĞIRLIK / Weight 1,582 kg/mt		SİNEKLİKLİ KASA PROFİLİ-1,4mm FLY SCREEN FRAME PROFILE	AĞIRLIK / Weight 2,498 kg/mt	
LS60 02			LS60 11		
KASA PROFİLİ FRAME PROFILE	AĞIRLIK / Weight 2,810 kg/mt		KANAT PROFİLİ SASH PROFILE	Jx cm ⁴ 43,22	
LS60 03			LS60 12		
KASA PROFİLİ FRAME PROFILE	AĞIRLIK / Weight 4,188 kg/mt		KANAT PROFİLİ-1,4mm SASH PROFILE	AĞIRLIK / Weight 2,071 kg/mt	
LS60 04			LS60 42		
KASA PROFİLİ FRAME PROFILE	AĞIRLIK / Weight 2,749 kg/mt		KENET PROFİLİ CENTRAL LOCKING PROFILE	AĞIRLIK / Weight 0,669 kg/mt	
LS60 08			LS60 112		
KASA PROFİLİ FRAME PROFILE	AĞIRLIK / Weight 2,344 kg/mt		DAR KANAT PROFİLİ SASH PROFILE	AĞIRLIK / Weight 1,249 kg/mt	
LS60 05			LS60 113		
KASA PROFİLİ-1,4mm FRAME PROFILE	AĞIRLIK / Weight 2,435 kg/mt		DAR KANAT PROFİLİ SASH PROFILE	AĞIRLIK / Weight 1,929 kg/mt	
LS60 05F			LS60 45		
SİNEKLİKLİ KASA PROFİLİ-1,4mm FLY SCREEN FRAME PROFILE	AĞIRLIK / Weight 2,940 kg/mt		KENET PROFİLİ CENTRAL LOCKING PROFILE	AĞIRLIK / Weight 0,402 kg/mt	
LS60 09			TH60 23		
KASA PROFİLİ-1,4mm FRAME PROFILE	AĞIRLIK / Weight 3,678 kg/mt		ORTA KAYIT PROFİLİ TRANSOM-MULLION PROFILE	AĞIRLIK / Weight 2,130 kg/mt	
LS60 09F			LS60 62		
KASA PROFİLİ-1,4mm FRAME PROFILE	AĞIRLIK / Weight 4,181 kg/mt		TH62 SİSTEM GEÇİŞ KASA PROFİLİ FRAME PROFILE FOR TH62	AĞIRLIK / Weight 2,423 kg/mt	
LS60 108			LS60 68		
KASA PROFİLİ-1,4mm FRAME PROFILE	AĞIRLIK / Weight 1,994 kg/mt		TH68 SİSTEM GEÇİŞ KASA PROFİLİ FRAME PROFILE FOR TH68	AĞIRLIK / Weight 2,411 kg/mt	











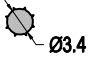







PROFİL LİSTESİ - PROFILES LIST

LS60 41			LS60 35		
ADAPTÖR PROFİLİ ADAPTER PROFILE	AĞIRLIK / Weight 0,967 kg/mt		KANAT SABİTLEME PROFİLİ SASH FIXING PROFILE	AĞIRLIK / Weight 0,672 kg/mt	
LS60 31			LS60 71		
KAPAK PROFİLİ COVER PROFILE	AĞIRLIK / Weight 0,685 kg/mt		KULP PROFİLİ HANDLE PROFILE	AĞIRLIK / Weight 2,050 kg/mt	
LS60 32			LS60 72		
DEKORATİF KAPAK PROFİLİ DECORATIVE COVER PROFILE	AĞIRLIK / Weight 0,709 kg/mt		KULP KAPAK PROFİLİ HANDLE COVER PROFILE	AĞIRLIK / Weight 0,420 kg/mt	
LS60-40			1042		
KAPAK PROFİLİ COVER PROFILE	AĞIRLIK / Weight 0,722 kg/mt		SİNEKLİK RAY PROFİLİ FLYSCREEN RAIL PROFILE	AĞIRLIK / Weight 0,551 kg/mt	
LS60 33			13-09986		
KAPAK PROFİLİ COVER PROFILE	AĞIRLIK / Weight 0,523 kg/mt		SİNEKLİK RAY PROFİLİ FLYSCREEN RAIL PROFILE	AĞIRLIK / Weight 0,741 kg/mt	
LS60 34			SL34T-52		
DEKORATİF KAPAK PROFİLİ DECORATIVE COVER PROFILE	AĞIRLIK / Weight 0,546 kg/mt		DAR SİNEKLİK KANAT PROFİLİ FLYSCREEN SASH PROFILE	AĞIRLIK / Weight 0,466 kg/mt	
LS60 43			12-71		
3'LÜ KANAT ADAPTÖR PROFİLİ ADAPTER PROFILE	AĞIRLIK / Weight 1,434 kg/mt		ADAPTÖR PROFİLİ ADAPTER PROFILE	AĞIRLIK / Weight 0,545 kg/mt	
LS60 61			12-72		
SİNEKLİK RAY PROFİLİ FLYSCREEN RAIL PROFILE	AĞIRLIK / Weight 0,391 kg/mt		ADAPTÖR PROFİLİ ADAPTER PROFILE	AĞIRLIK / Weight 0,285 kg/mt	
15-304216-09			LS60-44		
SİNEKLİK KANAT PROFİLİ FLYSCREEN SASH PROFILE	AĞIRLIK / Weight 0,351 kg/mt		İSPANYOLET KİLİTLEME ADAPTÖR PROFİLİ MULTI POINT LOCK ADAPTER	AĞIRLIK / Weight 0,284 kg/mt	
15-306317-11			SL-1515		
SİNEKLİK KANAT PROFİLİ FLYSCREEN SASH PROFILE	AĞIRLIK / Weight 0,561 kg/mt		KASA MONTAJ PROFİLİ FRAME ASSEMBLY PROFILE	AĞIRLIK / Weight 0,285 kg/mt	

PROFİL LİSTESİ - PROFILES LIST

11-004			11-032		
CAM ÇİTASI-4 mm GLAZING BEAD PROFILE	AĞIRLIK / Weight 0,181 kg/mt		CAM ÇİTASI-32 mm GLAZING BEAD PROFILE	AĞIRLIK / Weight 0,315 kg/mt	
11-106			11-035		
CAM ÇİTASI-6 mm GLAZING BEAD PROFILE	AĞIRLIK / Weight 0,200 kg/mt		CAM ÇİTASI-35 mm GLAZING BEAD PROFILE	AĞIRLIK / Weight 0,323 kg/mt	
11-010			11-038		
CAM ÇİTASI-10 mm GLAZING BEAD PROFILE	AĞIRLIK / Weight 0,233 kg/mt		CAM ÇİTASI-38 mm GLAZING BEAD PROFILE	AĞIRLIK / Weight 0,334 kg/mt	
11-015			12-52		
CAM ÇİTASI-15 mm GLAZING BEAD PROFILE	AĞIRLIK / Weight 0,242 kg/mt		PERVAZ PROFİLİ BORDER PROFILE	AĞIRLIK / Weight 0,279 kg/mt	
11-017			12-53		
CAM ÇİTASI-17 mm GLAZING BEAD PROFILE	AĞIRLIK / Weight 0,250 kg/mt		PERVAZ MONTAJ PROFİLİ BORDER FIXING PROFILE	AĞIRLIK / Weight 0,177 kg/mt	
11-020			12-54		
CAM ÇİTASI-20 mm GLAZING BEAD PROFILE	AĞIRLIK / Weight 0,276 kg/mt		PERVAZ PROFİLİ BORDER PROFILE	AĞIRLIK / Weight 0,326 kg/mt	
11-022			12-57		
CAM ÇİTASI-22 mm GLAZING BEAD PROFILE	AĞIRLIK / Weight 0,282 kg/mt		PERVAZ PROFİLİ BORDER PROFILE	AĞIRLIK / Weight 0,358 kg/mt	
11-026			10-010106-00		
CAM ÇİTASI-26 mm GLAZING BEAD PROFILE	AĞIRLIK / Weight 0,296 kg/mt		KÖŞE TAKOZU-10,6 mm CORNER JOINT	AĞIRLIK / Weight 2,653 kg/mt	
11-028			10-010140-00		
CAM ÇİTASI-28 mm GLAZING BEAD PROFILE	AĞIRLIK / Weight 0,302 kg/mt		KÖŞE TAKOZU-14,2 mm CORNER JOINT	AĞIRLIK / Weight 3,582 kg/mt	
11-030			10-010225-00		
CAM ÇİTASI-30 mm GLAZING BEAD PROFILE	AĞIRLIK / Weight 0,308 kg/mt		KÖŞE TAKOZU-22,5 mm CORNER JOINT	AĞIRLIK / Weight 3,564 kg/mt	

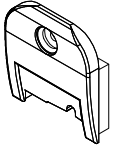

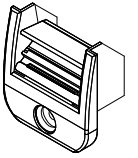



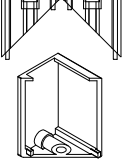
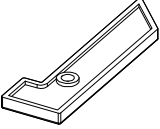
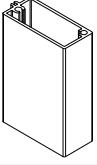
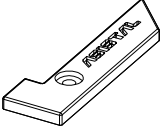
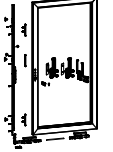
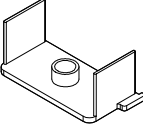
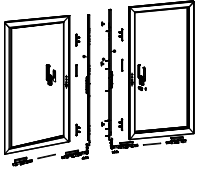
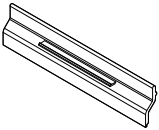
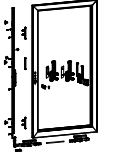
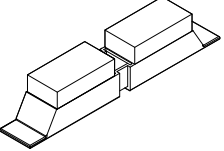
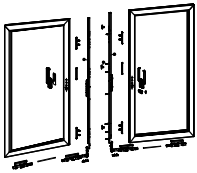
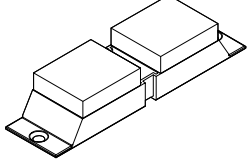
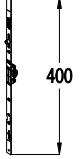
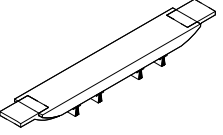
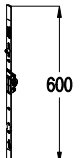
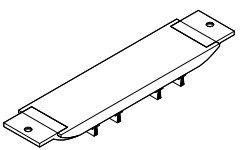
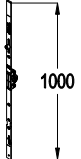
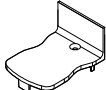
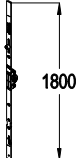

AKSESUAR LİSTESİ - ACCESSORIES LIST

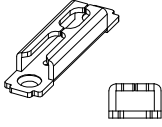
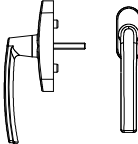
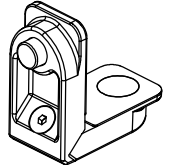
EP1-01			EP5-01		
DIŞ CAM FİTİLİ - 2,5 mm OUTER GLAZING GASKET	KOLİ MİKTARI/Package 240 mt / 15 kg		O.RING-3,4mm GASKET	KOLİ MİKTARI/Package mt / koli	
EP2-01			KF 67-600		
İÇ CAM FİTİLİ - 3 mm INNER GLAZING GASKET	KOLİ MİKTARI/Package 440 mt / 15 kg		FİRÇA FİTİL-6mm BRUSH GASKET	KOLİ MİKTARI/Package 1300 mt / koli	
EP2-02			KF 67-700		
İÇ CAM FİTİLİ - 4 mm INNER GLAZING GASKET	KOLİ MİKTARI/Package 300 mt / 15 kg		FİRÇA FİTİL-7mm BRUSH GASKET	KOLİ MİKTARI/Package 1100 mt / koli	
EP2-03			KF 67-1000		
İÇ CAM FİTİLİ - 5 mm INNER GLAZING GASKET	KOLİ MİKTARI/Package 250 mt / 15 kg		FİRÇA FİTİL-10mm BRUSH GASKET	KOLİ MİKTARI/Package 600 mt / koli	
EP60-03			MO60-10		
KANAT ÜST FİTİLİ SASH GASKET	KOLİ MİKTARI/Package 330 mt / 15 kg		KENET PVC PROFİL CENTRAL LOCKING PVC PROFILE	KOLİ MİKTARI/Package 6 mt / Adet	
EP60-04			MO60-11		
KENET FİTİLİ CENTRAL LOCKING GASKET	KOLİ MİKTARI/Package 300 mt / 15 kg		KENET PVC PROFİL CENTRAL LOCKING PVC PROFILE	KOLİ MİKTARI/Package 6 mt / Adet	
EP60-05			MO60-07		
KANAT FİTİLİ SASH GASKET	KOLİ MİKTARI/Package 300 mt / 15 kg		KASA KANAL PLASTİĞİ LS60 04 KASA İÇİN PVC PROFILE FOR LS60 04	KOLİ MİKTARI/Package 6 mt / Adet	
EP38-02			MO60-08		
KASA KANAL FİTİLİ FRAME GASKET	KOLİ MİKTARI/Package 535 mt / 15 kg		KASA KANAL PLASTİĞİ LS60 02 ve LS60 03 İÇİN PVC PROFILE FOR LS60 02 & LS60 03	KOLİ MİKTARI/Package 6 mt / Adet	
INT2-02			MO60-01		
KANAL FİTİLİ ADAPTER GASKET	KOLİ MİKTARI/Package 350 mt / 15 kg		KENET KAPAĞI-ALT INTERLOCK PROFILE-BOTTOM	KOLİ MİKTARI/Package Adet / Piece	
EP38-03			MO60-02		
SABİT ÇITA FİTİLİ FIXED FRAME GASKET	KOLİ MİKTARI/Package 145 mt / 13 kg		KENET KAPAĞI-ÜST INTERLOCK PROFILE-TOP	KOLİ MİKTARI/Package Adet / Piece	

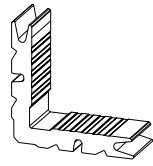
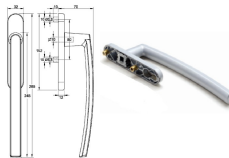
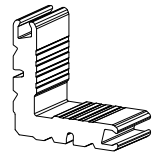
AKSESUAR LİSTESİ - ACCESSORIES LIST

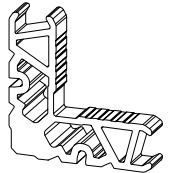
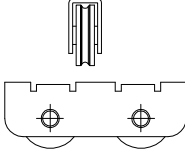
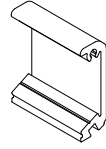
FLY-KP01			MO70-INT 01		
SİNEKLİK 90 KAPAĞI FLYSCREEN CAP	KOLİ MİKTARI/Package Adet / Piece		90°DAR KENET KAPAK TAKIMI - LS7013 COVER	KOLİ MİKTARI/Package Takım / Set	
MO60-03			LS60-DB 3560		
MO60-10 İÇİN KAPAK-ALT COVER FOR MO60-10-BOTTOM	KOLİ MİKTARI/Package Adet / Piece		KANAT SABİTLEME PARÇASI SASH FIXING	KOLİ MİKTARI/Package Adet / Piece	
MO60-04			LS60-MEK1		
MO60-10 İÇİN KAPAK-ÜST COVER FOR MO60-10-TOP	KOLİ MİKTARI/Package Adet / Piece		300 kg KAPASİTELİ KALDIR-SÜR MEKANİZMA LIFT & SLIDE MECHANISM	KOLİ MİKTARI/Package Takım / Set	
MO60-12			LS60-MEK1D		
4 LÜ KANAT KİLİTLEME ADAPTÖR KAPAĞI MEETING STILE CAP	KOLİ MİKTARI/Package Adet / Piece		300 kg KAPASİTELİ 4'LÜ KANAT MEKANİZMA LIFT & SLIDE MECHANISM	KOLİ MİKTARI/Package Takım / Set	
MO60-13			LS60-MEK2		
KANAT DENGELEME PLASTİĞİ SASH STABILIZATION SPACER	KOLİ MİKTARI/Package Adet / Piece		200 kg KAPASİTELİ KALDIR-SÜR MEKANİZMA LIFT & SLIDE MECHANISM	KOLİ MİKTARI/Package Takım / Set	
MO60-05D			LS60-MEK2D		
ALT HAVA KESİCİ LS60 04 KASA İÇİN CENTRAL SEALING-BOTTOM FOR LS60 04	KOLİ MİKTARI/Package Adet / Piece		200 kg KAPASİTELİ 4'LÜ KANAT MEKANİZMA LIFT & SLIDE MECHANISM	KOLİ MİKTARI/Package Takım / Set	
MO60-05G			ASI-ISP15.0		
ALT HAVA KESİCİ CENTRAL SEALING-BOTTOM	KOLİ MİKTARI/Package Adet / Piece		İSPANYOLET KİLİTLEME (400mm) - 15.5 AKS MULTI POINT LOCK	KOLİ MİKTARI/Package Adet / Piece	
MO60-06D			ASI-ISP15.1		
ÜST HAVA KESİCİ LS60 04 KASA İÇİN CENTRAL SEALING-TOP FOR LS60 04	KOLİ MİKTARI/Package Adet / Piece		İSPANYOLET KİLİTLEME (600mm) - 15.5 AKS MULTI POINT LOCK	KOLİ MİKTARI/Package Adet / Piece	
MO60-06G			ASI-ISP15.2		
ÜST HAVA KESİCİ CENTRAL SEALING-TOP	KOLİ MİKTARI/Package Adet / Piece		İSPANYOLET KİLİTLEME (1000mm)-15.5 AKS MULTI POINT LOCK	KOLİ MİKTARI/Package Adet / Piece	
MO60-19			ASI-ISP15.3		
KOL PROFİL KAPAĞI HANDLE PROFILE CAP	KOLİ MİKTARI/Package alt-üst takım / set		İSPANYOLET KİLİTLEME (1800mm) - 15.5 AKS MULTI POINT LOCK	KOLİ MİKTARI/Package Adet / Piece	

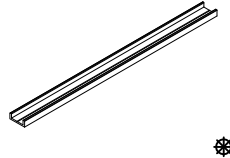
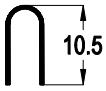
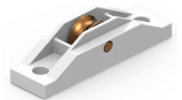
AKSESUAR LİSTESİ - ACCESSORIES LIST

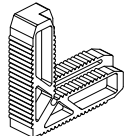
ASI-ISP K03			ASI-PB 1126		
İSPANYOLET KİLİT KARŞILIK MULTI POINT LOCK STRIKER	KOLİ MİKTARI/Package Adet / Piece		PİMLİ KÖŞE BAĞLANTI CORNER JOINT	KOLİ MİKTARI/Package 11 x 26 mm	
ASI-WH 002			ASI-PB 1124 (MON / 0404)		
İSPANYOLET KİLİTLEME KOL MULTI POINT LOCK HANDLE	KOLİ MİKTARI/Package Adet / Piece		KÖŞE BAĞLANTI CORNER JOINT	KOLİ MİKTARI/Package 11 x 24 mm	
ASI-LS-H01			ASI-KT 1126		
LAVAAL KALDIR-SÜR KOLU LIFT&SLIDE HANDLE	KOLİ MİKTARI/Package Takım / Set		KÖŞE TAKOZU CORNER JOINT	KOLİ MİKTARI/Package Adet / Piece	
ASI-LS-H01A			ASI-KT 1429		
LAVAAL KALDIR-SÜR KOLU TEKLİ LIFT&SLIDE HANDLE SINGLE	KOLİ MİKTARI/Package Adet / Piece		KÖŞE TAKOZU CORNER JOINT	KOLİ MİKTARI/Package Adet / Piece	
ASI-LS-H02			ASI-KT 2307		
LAVAAL KALDIR-SÜR KOLU KİLİTLİ LIFT&SLIDE HANDLE LOCK	KOLİ MİKTARI/Package Takım / Set		KÖŞE TAKOZU CORNER JOINT	KOLİ MİKTARI/Package Adet / Piece	
ASI-SR 04			ASI-DB 9143		
NORMAL SÜRME RULMAN (U TİPİ RAY) NORMAL SLIDING ROLLER FOR RAIL TYPE - U	KOLİ MİKTARI/Package Adet / Piece		DİK BAĞLANTI T JOINT	KOLİ MİKTARI/Package Adet / Piece	
ASI-SR 02R			ASI-SL1520		
AYARLI ÇİFTLİ RULMAN (U TİPİ RAY İÇİN) DOUBLE SLIDING ROLLER FOR RAIL TYPE - U	KOLİ MİKTARI/Package Adet / Piece		KASA MONTAJ PARÇASI FRAME ASSEMBLY PART	KOLİ MİKTARI/Package Adet / Piece	
ASI-INR 03			ASI-5025		
ÇELİK RAY STEEL RAIL_LS60-LSDR	KOLİ MİKTARI/Package 6 mt / Adet		SİNEKLİK FİTLİ FLYSCREEN GASKET	KOLİ MİKTARI/Package 100 mt	
ASI-INR 02			ASI-BZ 5060		
ÇELİK RAY STEEL RAIL_LS60-SD	KOLİ MİKTARI/Package 6 mt / Adet		SİNEKLİK KANAT RULMAN FLYSCREEN SASH ROLLER	KOLİ MİKTARI/Package Adet / Piece	
ASI-SB 19.1			ASI-BZ 5007		
KÖŞE GÖNYESİ CORNER ALIGNMENT	KOLİ MİKTARI/Package 1000 Adet / Piece		SİNEKLİK KÖŞE TAKOZU FLYSCREEN CORNER JOINT	KOLİ MİKTARI/Package Adet / Piece	

LS60 - 1,8mm

YALITIMLI KALDIR-SÜR SİSTEMİ
THERMAL LIFT&SLIDE SYSTEM

ASISTAL

PROFİL DETAYLARI
PROFILE DETAILS

LS60

YALITIMLI KALDIR-SÜR SİSTEM
THERMAL LIFT&SLIDE SYSTEM

ASISTAL

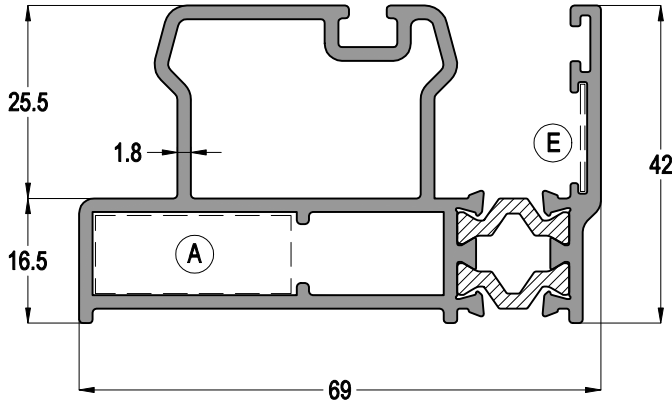

LS60 01

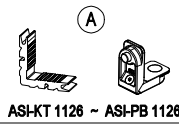

AĞIRLIK / Weight

1,582 kg/mt

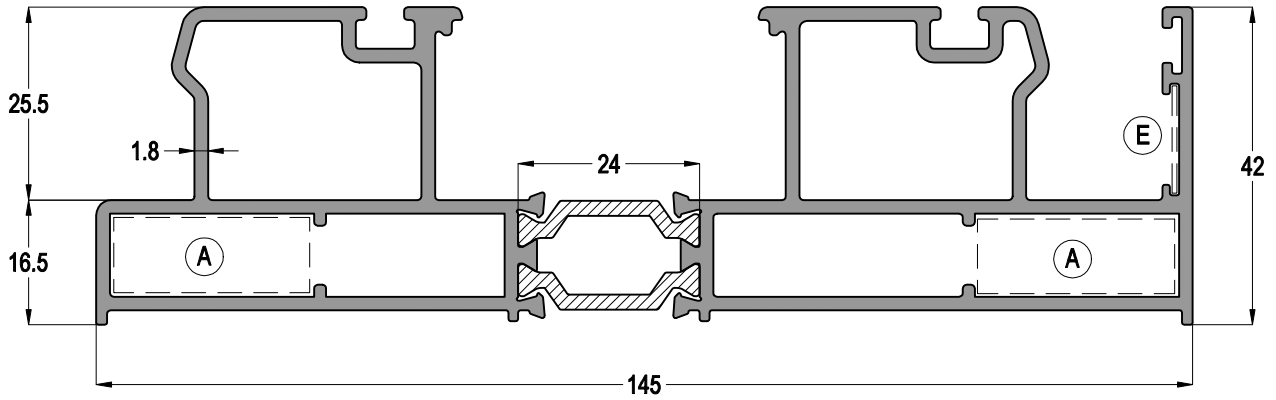

LS60 02

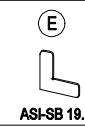
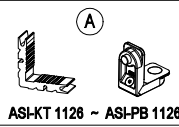

AĞIRLIK / Weight



2,810 kg/mt

LS60

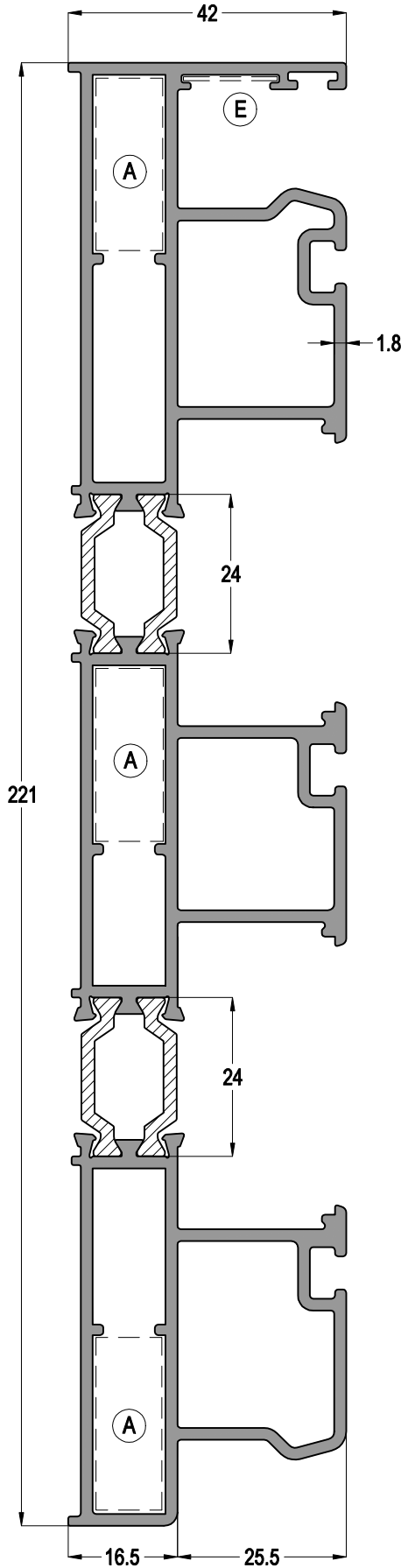
YALITIMLI KALDIR-SÜR SİSTEM
THERMAL LIFT&SLIDE SYSTEM



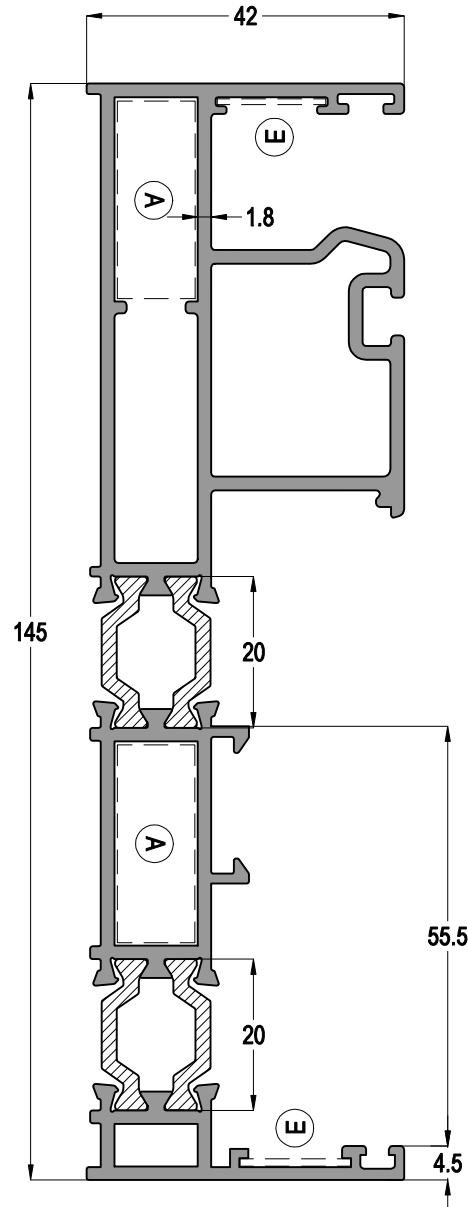

LS60 03

 ASI-KT 1126 ~ ASI-PB 1126	 ASI-SB 19.1	AĞIRLIK / Weight 4,188 kg/mt
--	---	---------------------------------

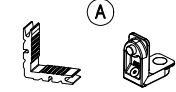

LS60 04

 ASI-KT 1126 ~ ASI-PB 1126	 ASI-SB 19.1	AĞIRLIK / Weight 2,749 kg/mt
---	--	---------------------------------

Profil ağırlıklarımız teorik olup; teslim anındaki tartımız geçerlidir.
Profile weights are theoretical and the weight at the time of delivery is valid.

LS60

YALITIMLI KALDIR-SÜR SİSTEM
THERMAL LIFT&SLIDE SYSTEM

ASISTAL

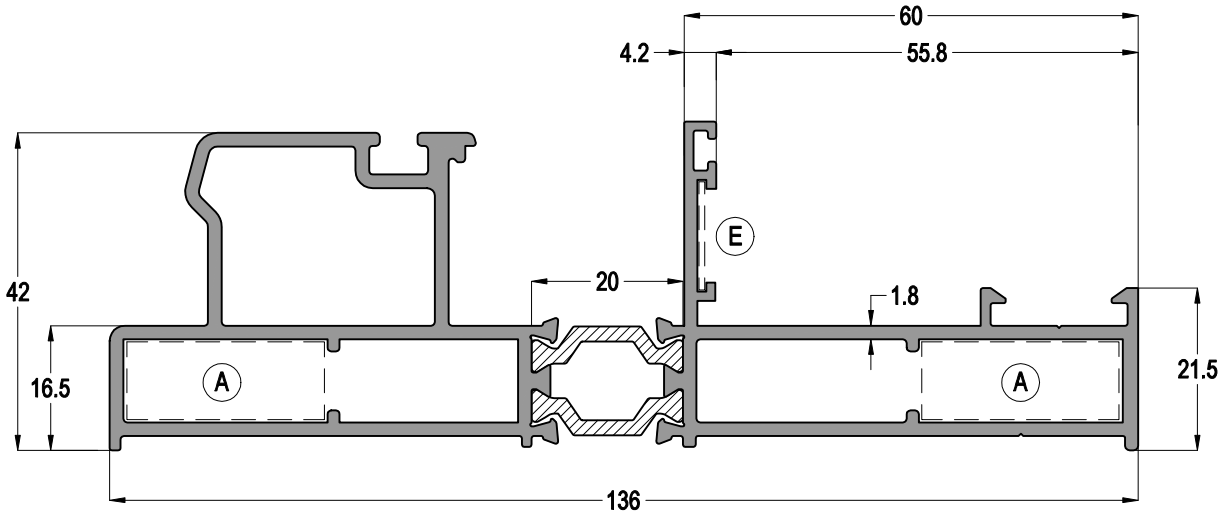

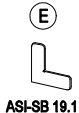
LS60 08		
		AĞIRLIK / Weight
		2,344 kg/mt

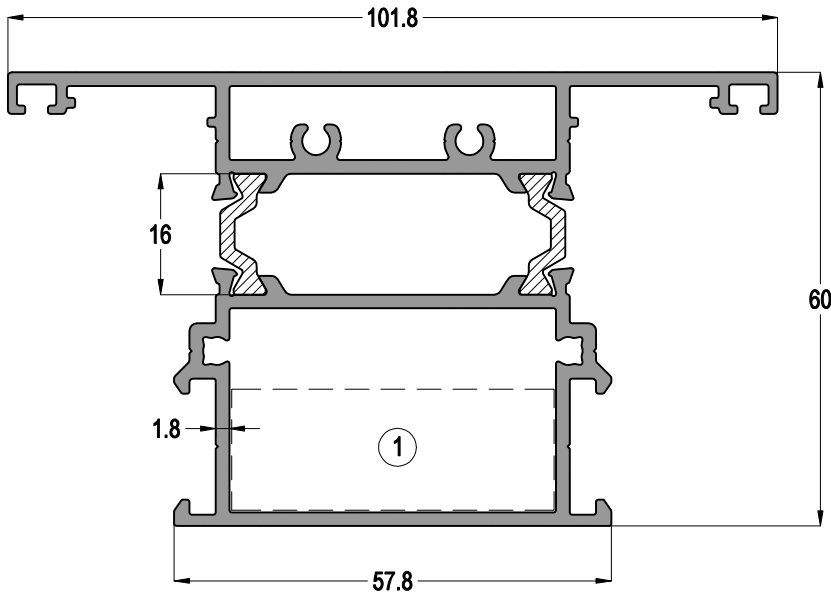

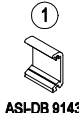
TH60 23		
		AĞIRLIK / Weight
		2,130 kg/mt

* Sipariş öncesi kalıp bilgisi kontrol edilmeli / profile mold must be checked before the order



Profil ağırlıklarımız teorik olup; teslim anındaki tartımız geçerlidir.
Profile weights are theoretical and the weight at the time of delivery is valid.

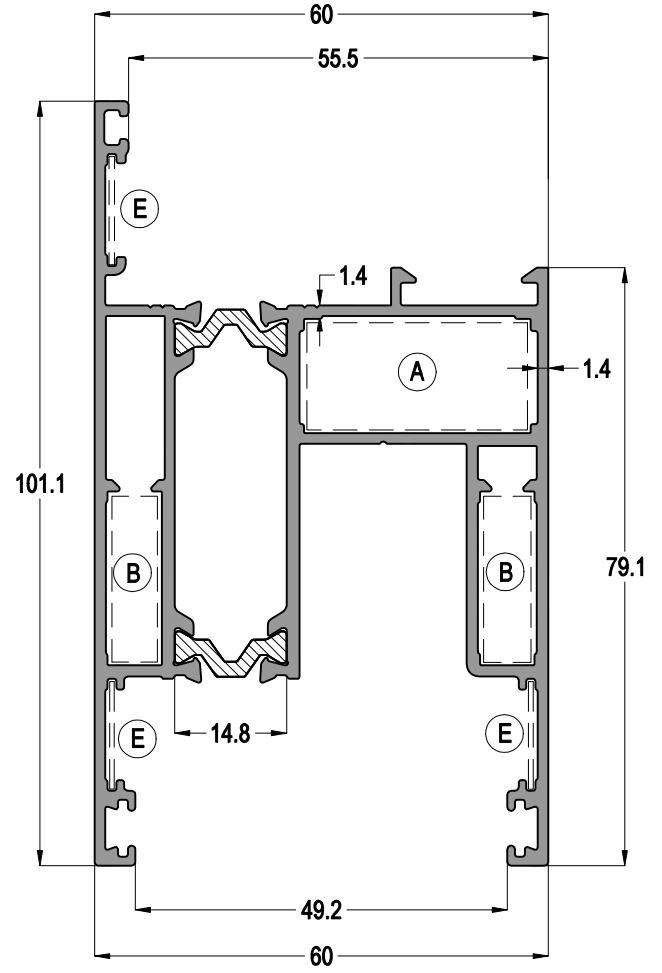
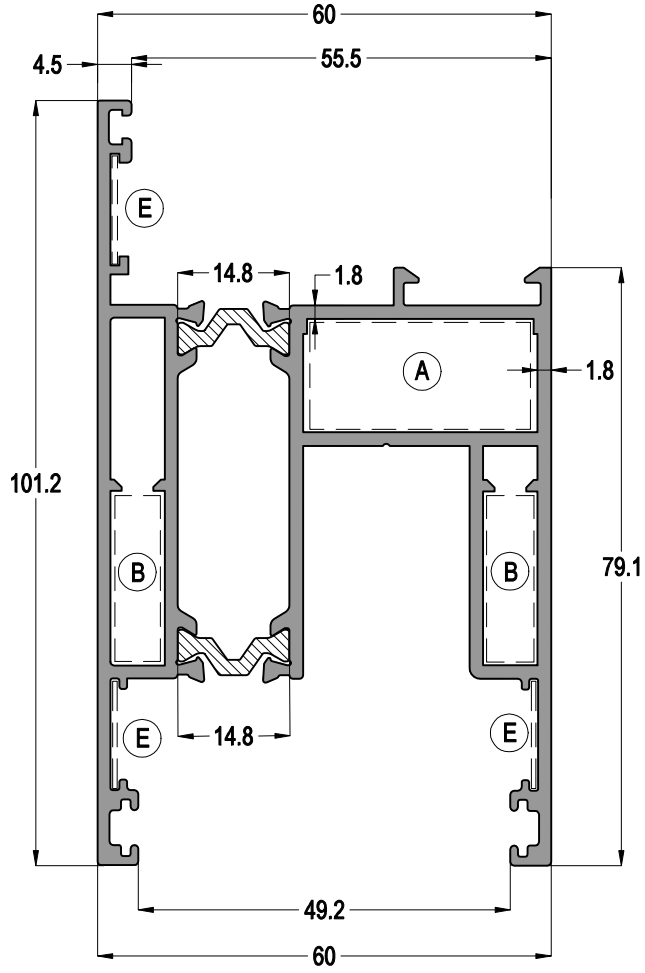

LS60

YALITIMLI KALDIR-SÜR SİSTEM
THERMAL LIFT&SLIDE SYSTEM

ASISTAL



LS60 11			Jx cm ⁴	Jy cm ⁴
			43,22	49,37
			AĞIRLIK / Weight	
ASI-KT 1429	ASI-KT 2307	ASI-SB 19.1	2,314 kg/mt	

LS60 12			Jx cm ⁴	Jy cm ⁴
			36,03	47,29
			AĞIRLIK / Weight	
ASI-KT 1429	ASI-KT 2307	ASI-SB 19.1	2,183 kg/mt	

* Sipariş öncesi kalıp bilgisi kontrol edilmeli / profile mold must be checked before the order



Profil ağırlıklarımız teorik olup; teslim anındaki tartımız geçerlidir.
Profile weights are theoretical and the weight at the time of delivery is valid.

LS60 - 1,8mm

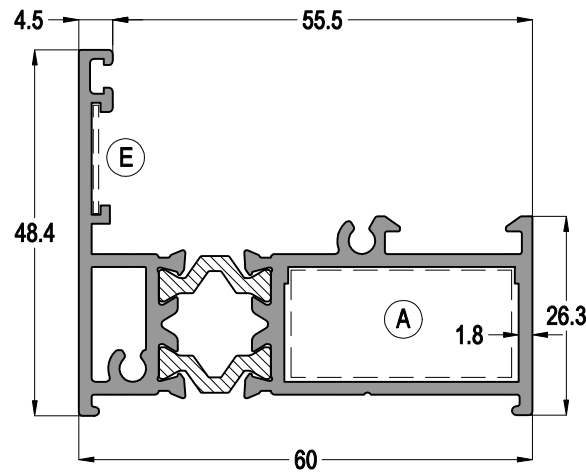

YALITIMLI KALDIR-SÜR SİSTEM
THERMAL LIFT&SLIDE SYSTEM

ASISTAL

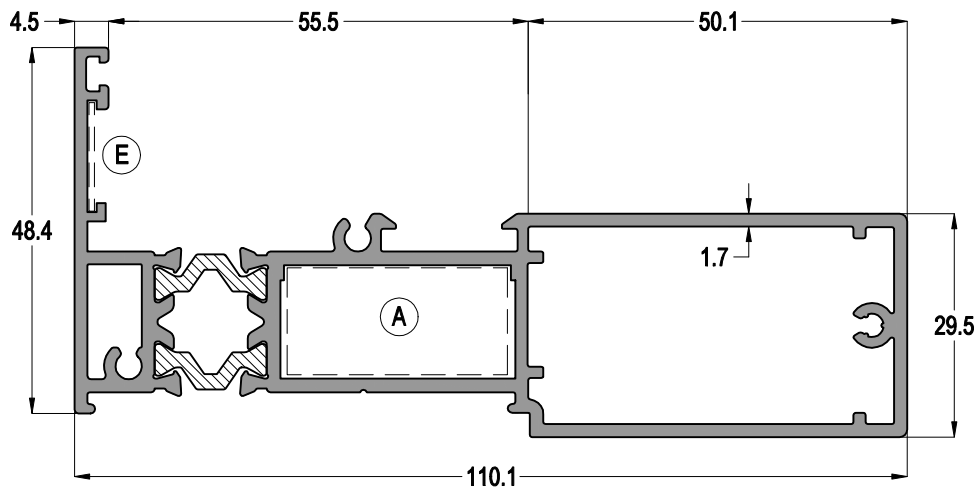

LS60 112		Jx cm ⁴	Jy cm ⁴
		19,15	5,20
 ASI-KT 1429	 ASI-SB 19.1	AĞIRLIK / Weight	
		1,249 kg/mt	



LS60 113		Jx cm ⁴	Jy cm ⁴
		99,15	9,16
 ASI-KT 1429	 ASI-SB 19.1	AĞIRLIK / Weight	
		1,929 kg/mt	



LS60 - 1,4mm

YALITIMLI KALDIR-SÜR SİSTEM
THERMAL LIFT&SLIDE SYSTEM

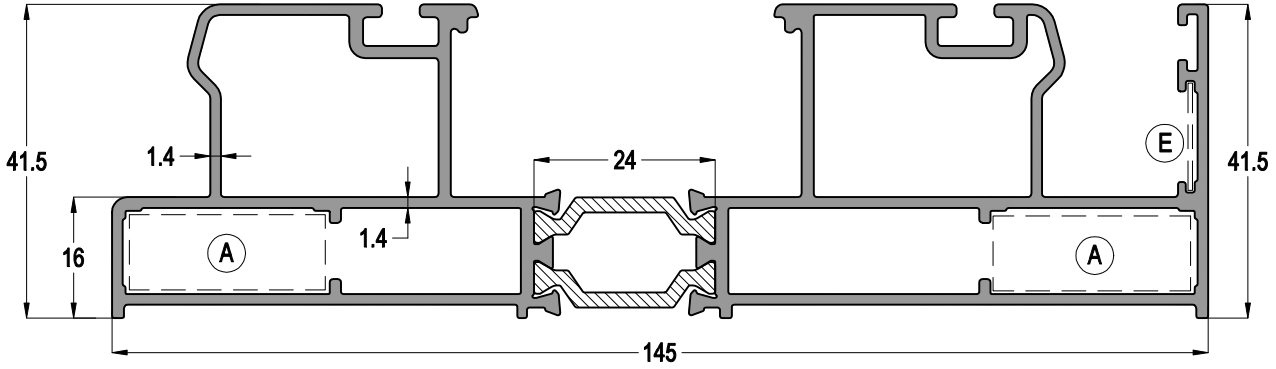
ASISTAL



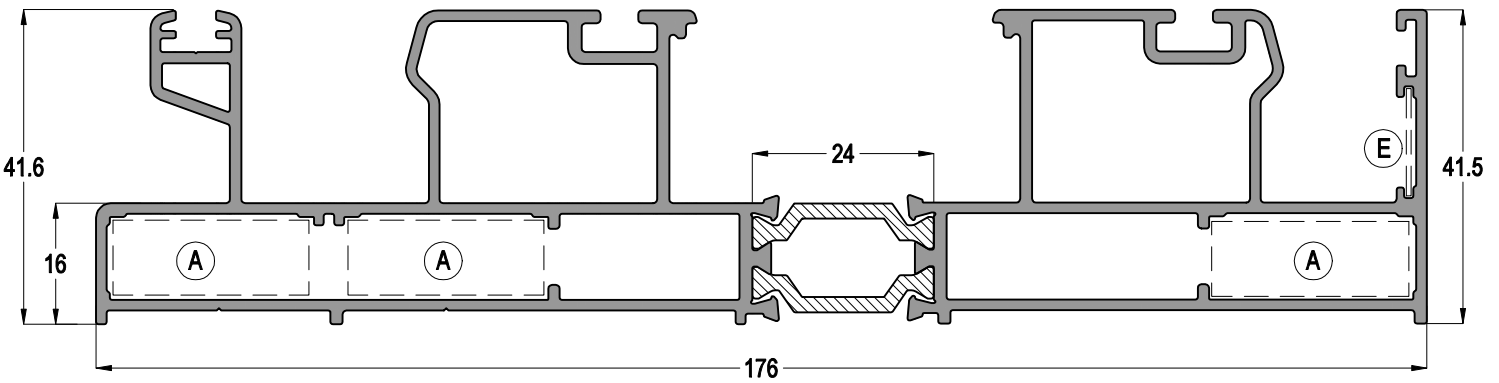

LS60 05

		AĞIRLIK / Weight
		2,435 kg/mt



LS60 05F

		AĞIRLIK / Weight
		2,932 kg/mt

⊛ Sipariş öncesi kalıp bilgisi kontrol edilmeli / profile mold must be checked before the order

Profil ağırlıklarımız teorik olup; teslim anındaki tartımız geçerlidir.
Profile weights are theoretical and the weight at the time of delivery is valid.



LS60 - 1,4mm

YALITIMLI KALDIR-SÜR SİSTEM
THERMAL LIFT&SLIDE SYSTEM

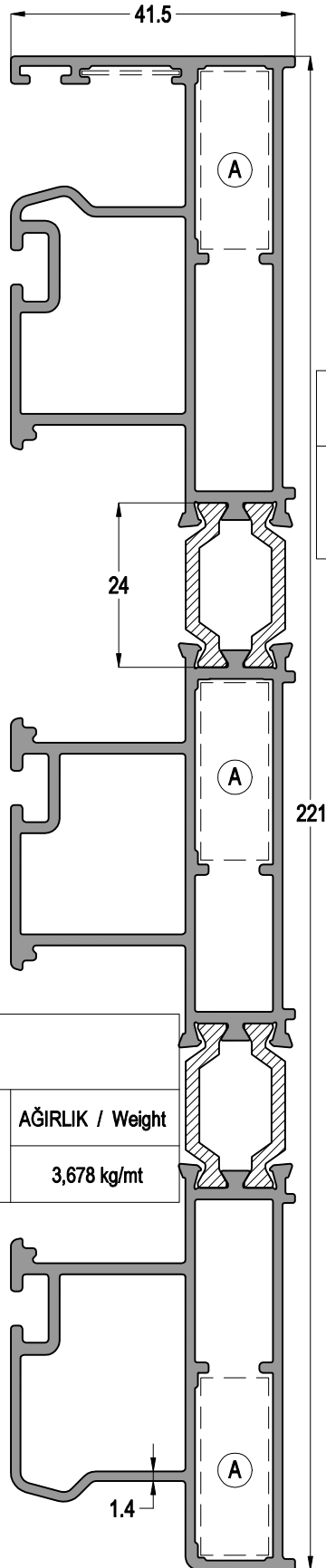
ASISTAL



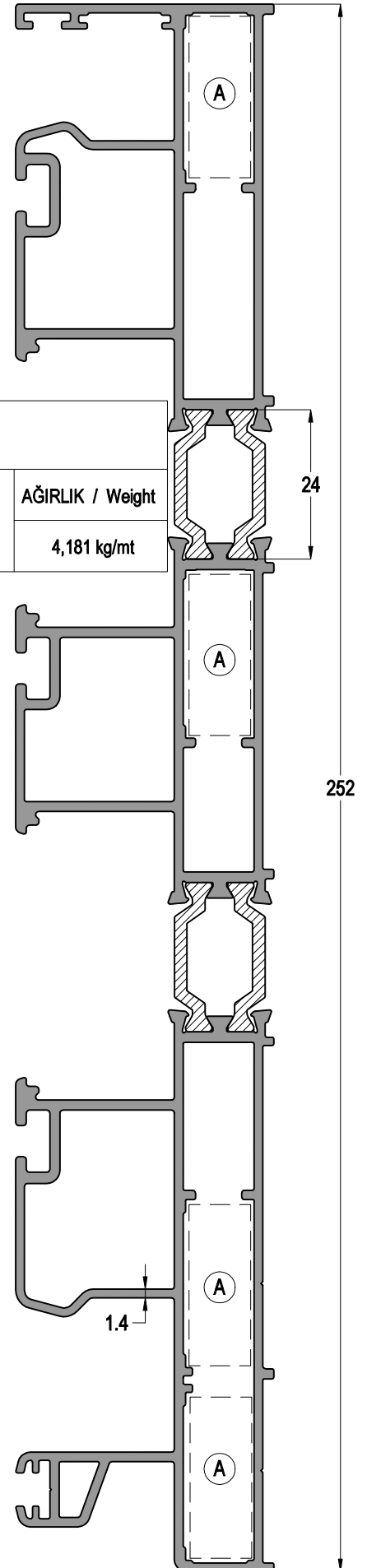

LS60 09F

		AĞIRLIK / Weight
ASI-KT 1126 ~ ASI-PB 1126	ASI-SB 19.1	4,181 kg/mt



LS60 09

		AĞIRLIK / Weight
ASI-KT 1126 ~ ASI-PB 1126	ASI-SB 19.1	3,678 kg/mt



* Sipariş öncesi kalıp bilgisi kontrol edilmeli / profile mold must be checked before the order

Profil ağırlıklarımız teorik olup; teslim anındaki tartımız geçerlidir.
Profile weights are theoretical and the weight at the time of delivery is valid.

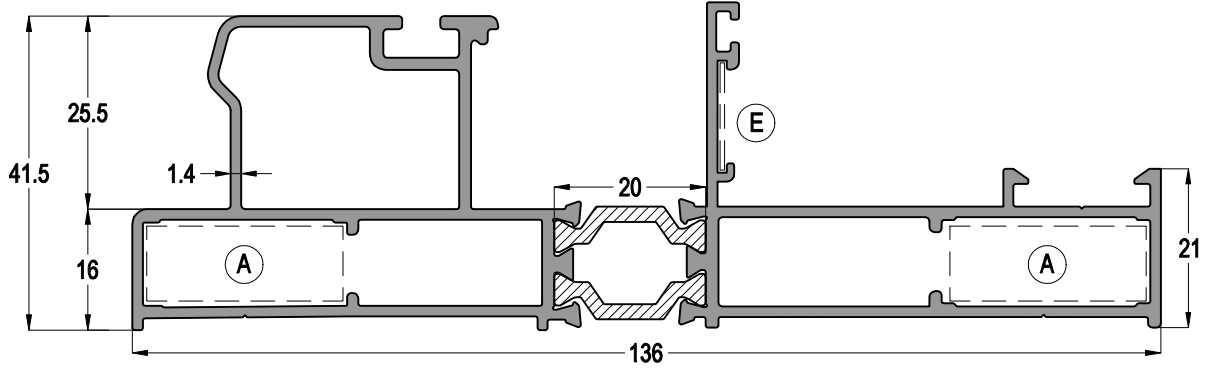

LS60 - 1,4mm

YALITIMLI KALDIR-SÜR SİSTEM
THERMAL LIFT&SLIDE SYSTEM

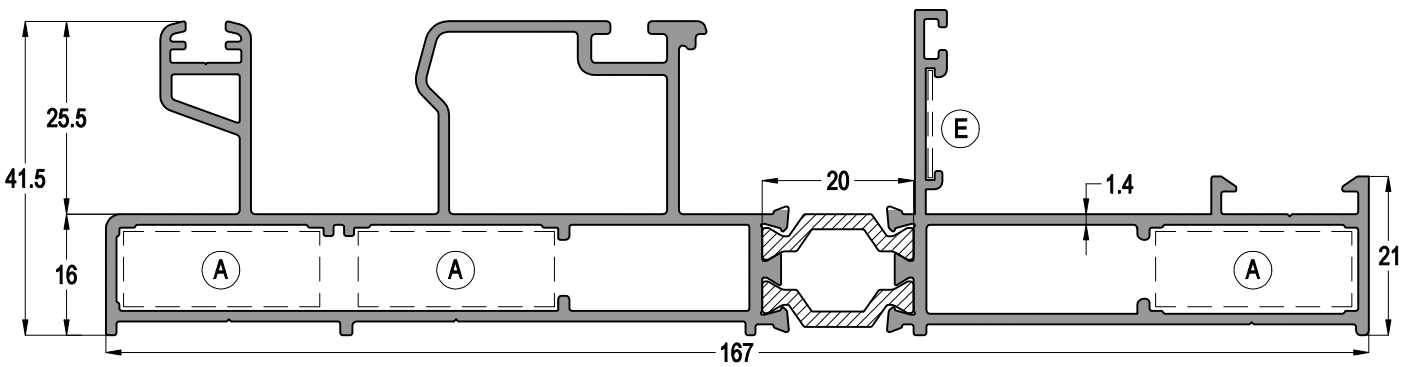

LS60 108		
 ASI-KT 1126 ~ ASI-PB 1126	 ASI-SB 19.1	AĞIRLIK / Weight
		1.994 kg/mt



LS60 108F		
 ASI-KT 1126 ~ ASI-PB 1126	 ASI-SB 19.1	AĞIRLIK / Weight
		2.498 kg/mt

Profil ağırlıklarımız teorik olup; teslim anındaki tartımız geçerlidir.
Profile weights are theoretical and the weight at the time of delivery is valid.

LS60

YALITIMLI KALDIR-SÜR SİSTEM
THERMAL LIFT&SLIDE SYSTEM

ASISTAL

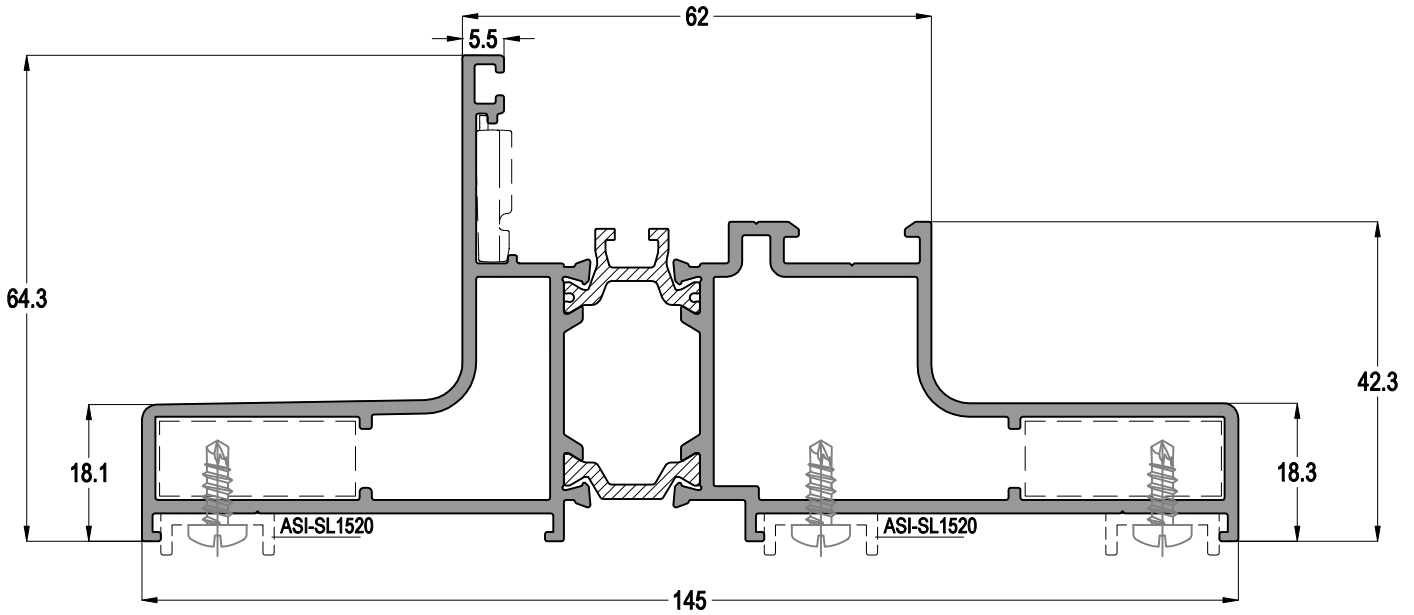

LS60 62

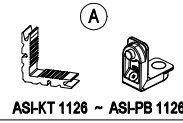

AĞIRLIK / Weight

2,423 kg/mt

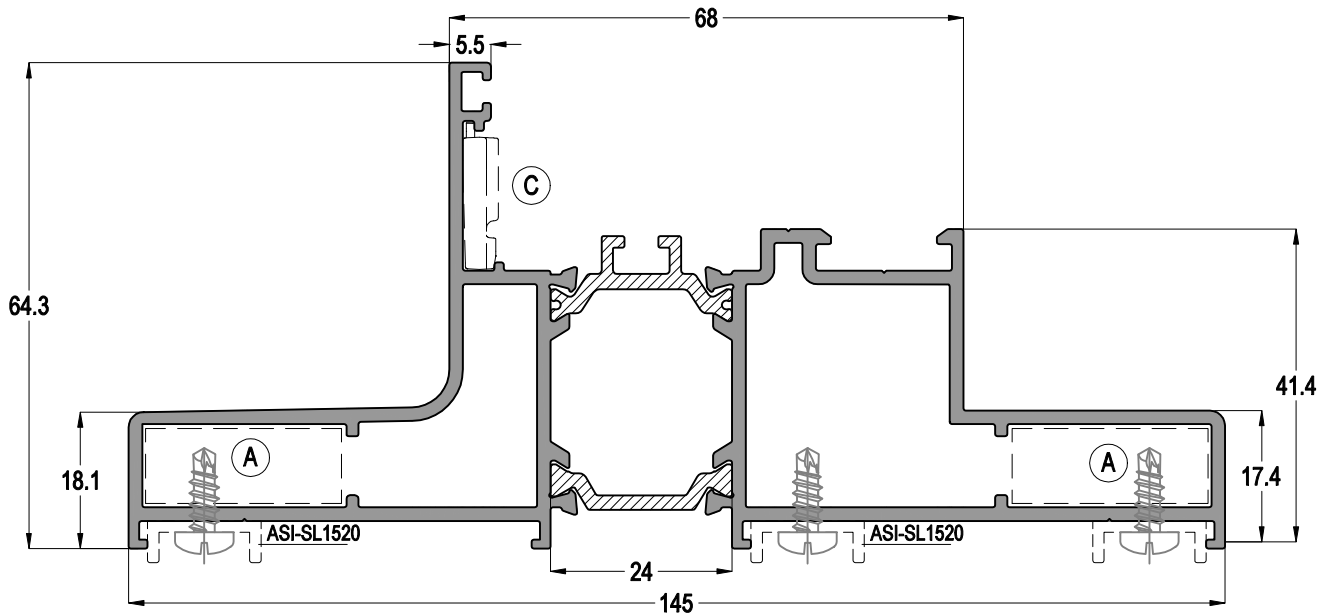

LS60 68

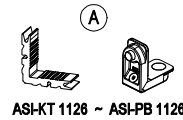

AĞIRLIK / Weight

2,411 kg/mt

⊗ Sipariş öncesi kalıp bilgisi kontrol edilmeli / profile mold must be check before the order

Profil ağırlıklarımız teorik olup; teslim anındaki tartımız geçerlidir.
Profile weights are theoretical and the weight at the time of delivery is valid.

LS60

YALITIMLI KALDIR-SÜR SİSTEM
THERMAL LIFT&SLIDE SYSTEM

ASISTAL

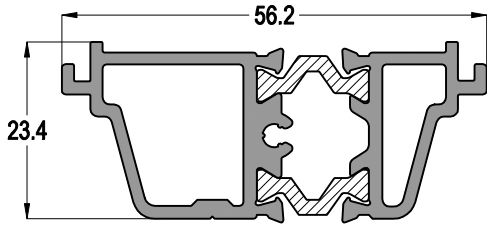

LS60 41



MO80-12

AĞIRLIK / Weight

0,967 kg/mt

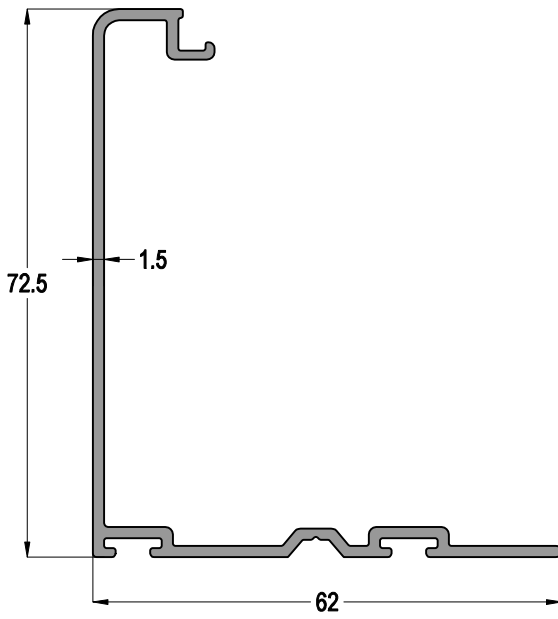

LS60 42

AĞIRLIK / Weight

0,669 kg/mt

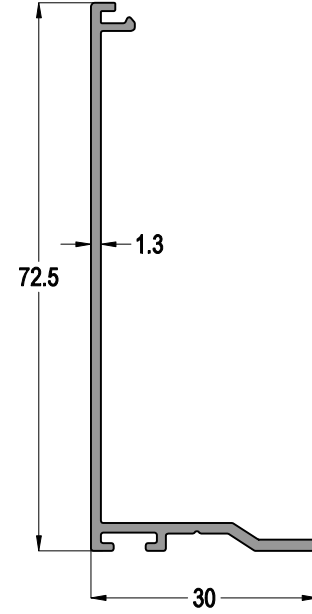

LS60 45

AĞIRLIK / Weight

0,402 kg/mt

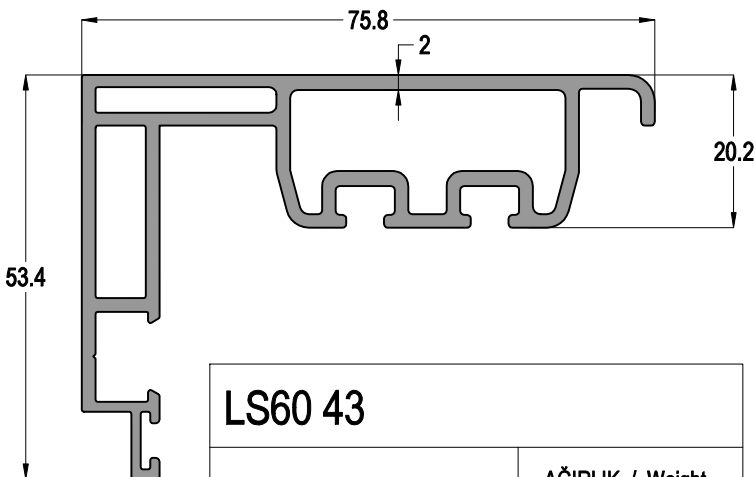

LS60 43

AĞIRLIK / Weight

1,434 g/mt

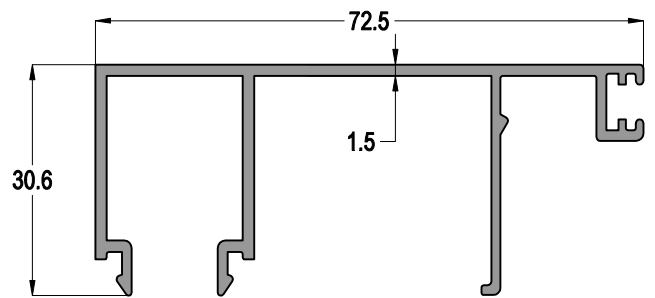

LS60 40

AĞIRLIK / Weight

0,722 kg/mt

✳ Sipariş öncesi kalıp bilgisi kontrol edilmeli / must be check profile mold before the order

Profil ağırlıklarımız teorik olup; teslim anındaki tartımız geçerlidir.
Profile weights are theoretical and the weight at the time of delivery is valid.

LS60

YALITIMLI KALDIR-SÜR SİSTEM
THERMAL LIFT&SLIDE SYSTEM

ASISTAL

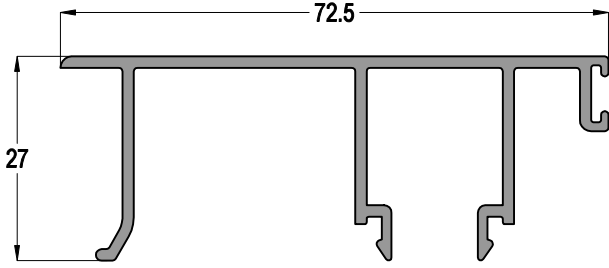

LS60 31

AĞIRLIK / Weight	
	0,685 kg/mt

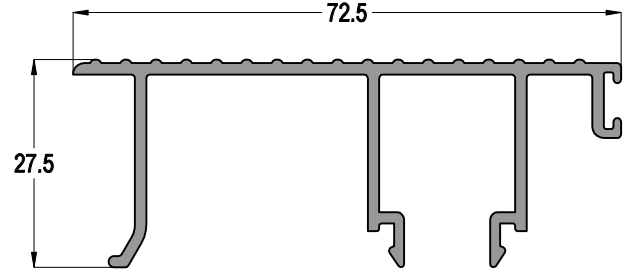

LS60 32

AĞIRLIK / Weight	
	0,709 kg/mt

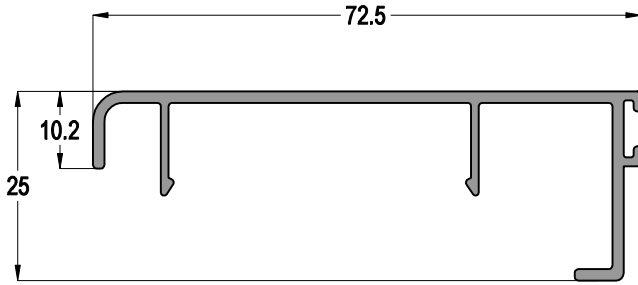

LS60 33

AĞIRLIK / Weight	
	0,523 kg/mt

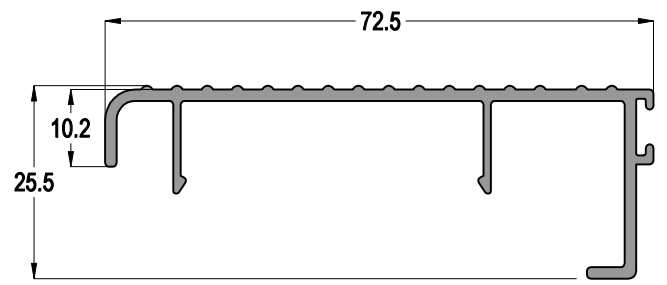

LS60 34

AĞIRLIK / Weight	
	0,546 kg/mt

LS60

YALITIMLI KALDIR-SÜR SİSTEM
THERMAL LIFT&SLIDE SYSTEM

ASISTAL

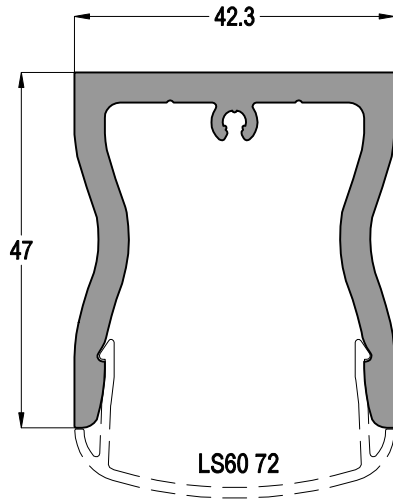

LS60 71	
 MO80-19	AĞIRLIK / Weight 2,050 kg/mt

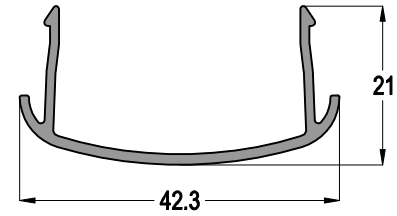

LS60 72	
	AĞIRLIK / Weight 0,420 kg/mt

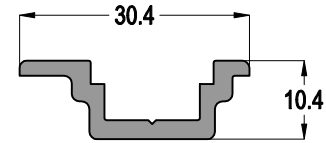

LS60 44	
	AĞIRLIK / Weight 0,284 kg/mt

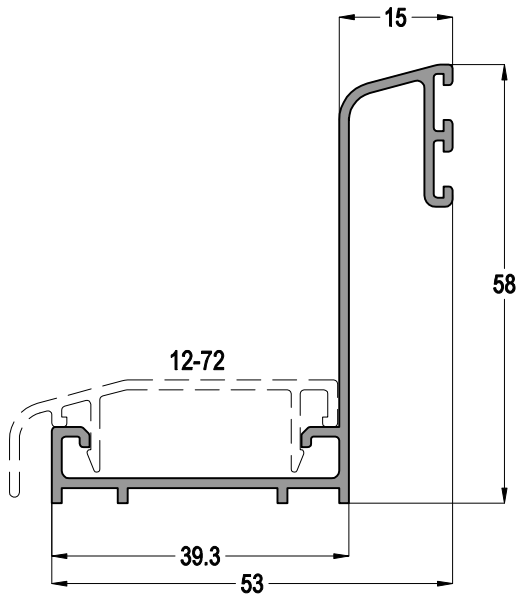

12-71	
	AĞIRLIK / Weight 0,545 kg/mt

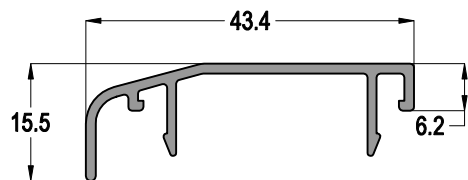

12-72	
	AĞIRLIK / Weight 0,285 kg/mt

LS60

YALITIMLI KALDIR-SÜR SİSTEM
THERMAL LIFT&SLIDE SYSTEM

ASISTAL

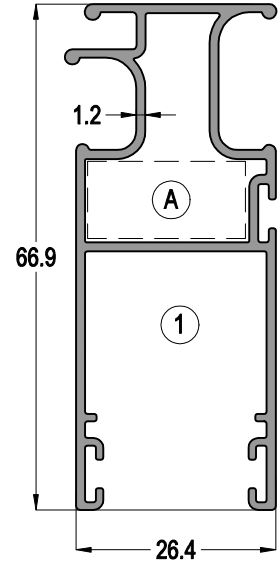
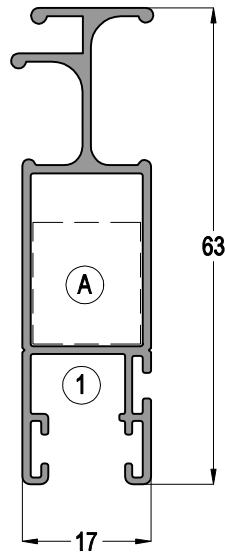
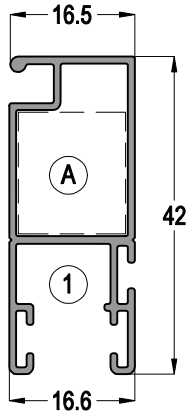

15-304216-09



ASI-BZ 5007



ASI-BZ 5060

AĞIRLIK / Weight

0,351 kg/mt

15-306317-11

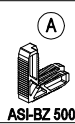

ASI-BZ 5007



ASI-BZ 5060

AĞIRLIK / Weight

0,561 kg/mt

13-09986



ASI-PB 1119

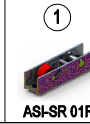

ASI-SR 01R

AĞIRLIK / Weight

0,741 kg/mt

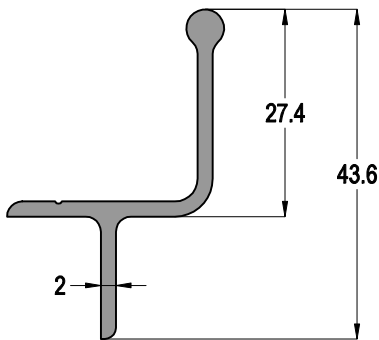

LS60 61

0,391 kg/mt

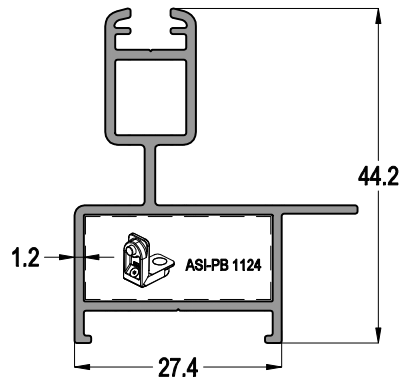

1042

0,551 kg/mt

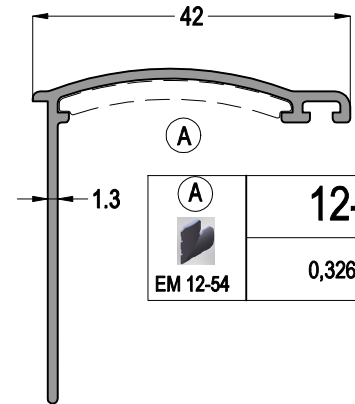

12-54

0,326 kg/mt

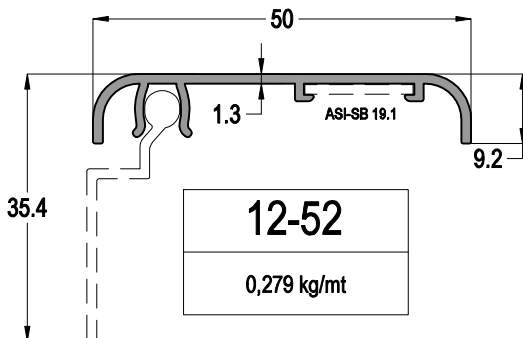

12-52

0,279 kg/mt

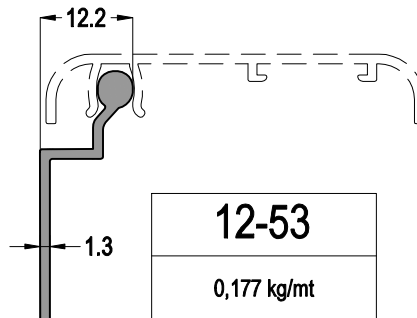

12-53

0,177 kg/mt

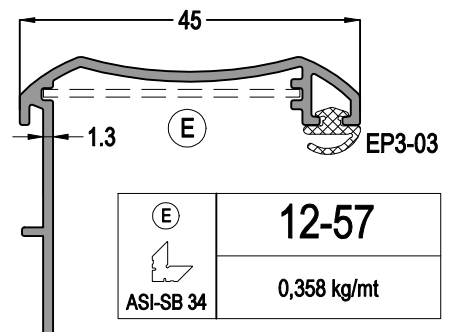

12-57

0,358 kg/mt

Profil ağırlıklarımız teorik olup; teslim anındaki tartımız geçerlidir.
Profile weights are theoretical and the weight at the time of delivery is valid.

LS60 - 1,8mm

YALITIMLI KALDIR-SÜR SİSTEM
THERMAL LIFT&SLIDE SYSTEM

ASISTAL

11-004

0,181 kg/mt

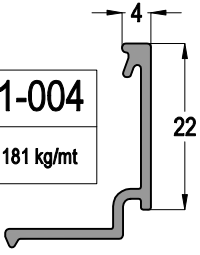

11-106

0,200 kg/mt

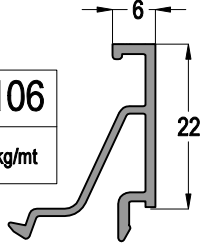

11-010

0,233 kg/mt

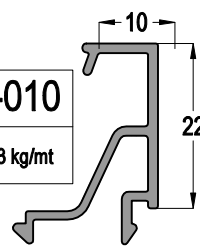

11-015

0,242 kg/mt

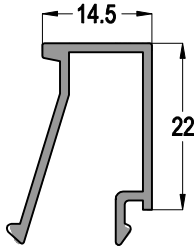

11-017

0,250 kg/mt

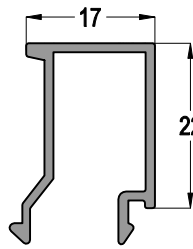

11-020

0,276 kg/mt

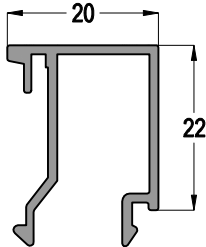

11-022

0,282 kg/mt

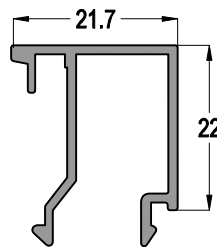

11-026

0,296 kg/mt

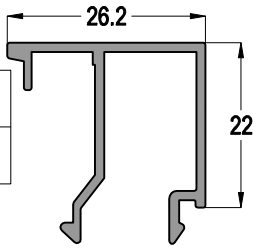

11-028

0,302 kg/mt

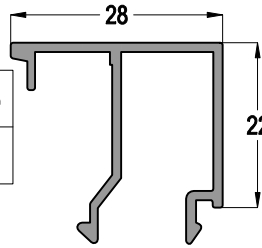

11-030

0,308 kg/mt

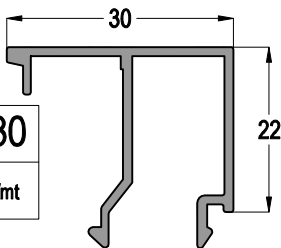

11-032

0,315 kg/mt

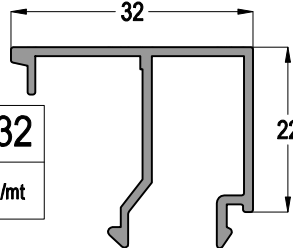

11-035

0,323 kg/mt

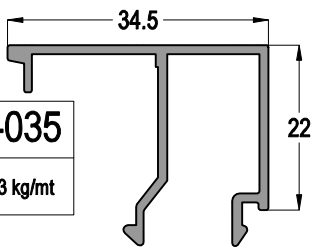

11-038

0,334 kg/mt

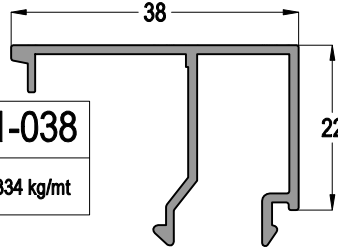

CAM KALINLIĞINA GÖRE CAM ÇİTASI SEÇİM TABLOSU
Glazing Bead Selection Table according to the Glass Thickness

CAM KALINLIĞI Glass Thickness (mm)	CAM ÇİTASI Glazing Bead	İÇ CAM FITİLİ Glass Gasket (IN)	DIŞ CAM FITİLİ Glass Gasket (OUT)
10	11-038	EP2-02	EP1-01
11	11-038	EP2-01	EP1-01
12	11-035	EP2-03	EP1-01
13	11-035	EP2-02	EP1-01
14	11-035	EP2-01	EP1-01
15	11-032	EP2-03	EP1-01
16	11-032	EP2-02	EP1-01
17	11-032	EP2-01	EP1-01
18	11-030	EP2-02	EP1-01
19	11-030	EP2-01	EP1-01
20	11-028	EP2-02	EP1-01
21	11-028	EP2-01	EP1-01
22	11-026	EP2-02	EP1-01
23	11-026	EP2-01	EP1-01
24	11-022	EP2-03	EP1-01
25	11-022	EP2-02	EP1-01
26	11-022	EP2-01	EP1-01
28	11-020	EP2-02	EP1-01
29	11-020	EP2-01	EP1-01
30	11-017	EP2-03	EP1-01
31	11-017	EP2-02	EP1-01
32	11-017	EP2-01	EP1-01
33	11-015	EP2-02	EP1-01
34	11-015	EP2-01	EP1-01
38	11-010	EP2-02	EP1-01
39	11-010	EP2-01	EP1-01
40	11-106	EP2-03	EP1-01
42	11-106	EP2-02	EP1-01
43	11-106	EP2-01	EP1-01
44	11-004	EP2-02	EP1-01
45	11-004	EP2-02	EP1-01
46	11-004	KC-02	EP1-01

AÇILIM TİPLERİ NORMAL SÜRME - OPENING TYPES NORMAL SLIDING

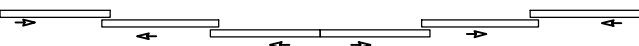
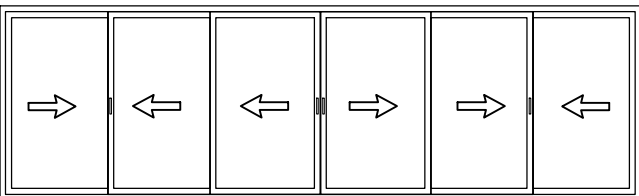
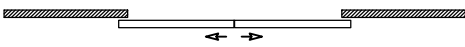
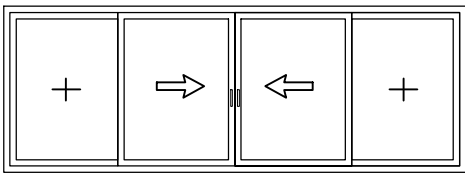
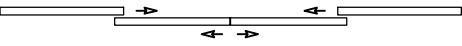
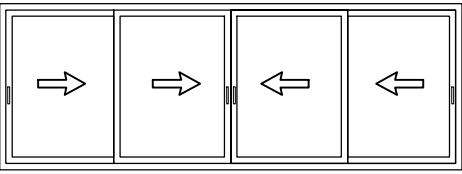
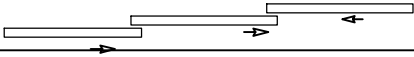
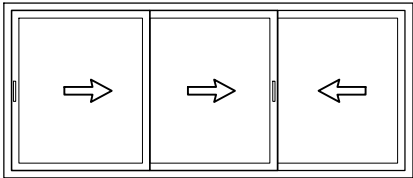
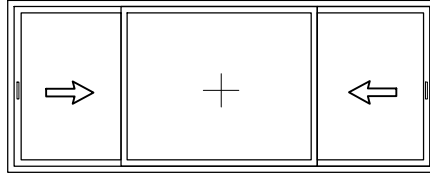
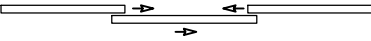
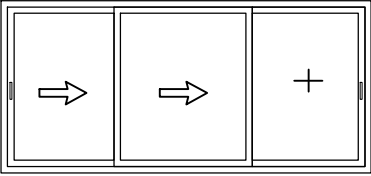
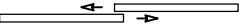
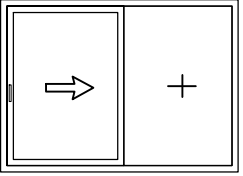
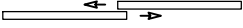
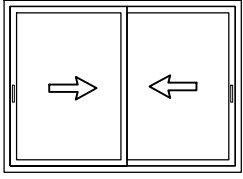

AÇILIM TİPLERİ KALDIR-SÜR SÜRME - OPENING TYPES LIFT & SLIDING

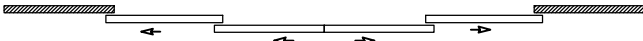
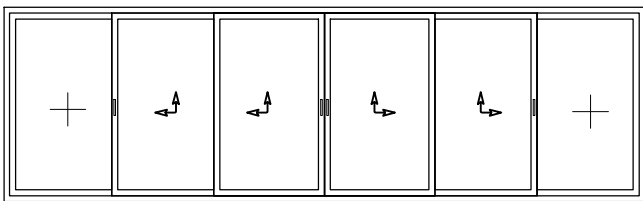
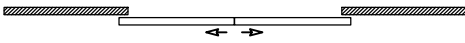
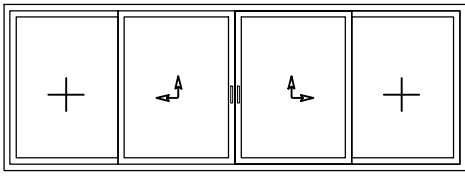
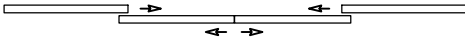
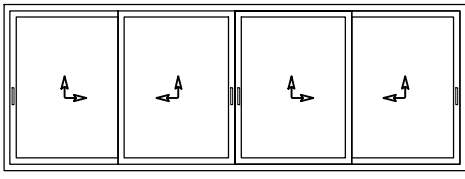
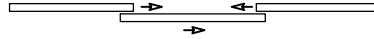
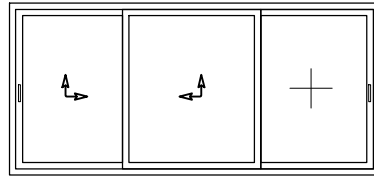
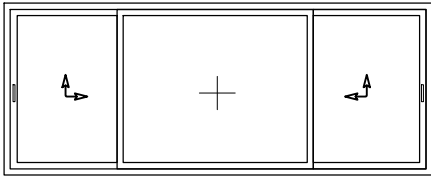
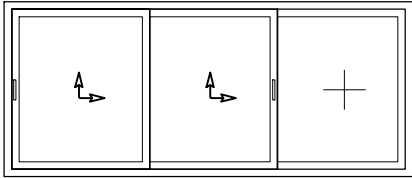
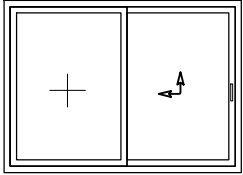
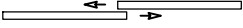
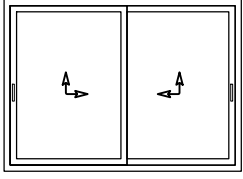

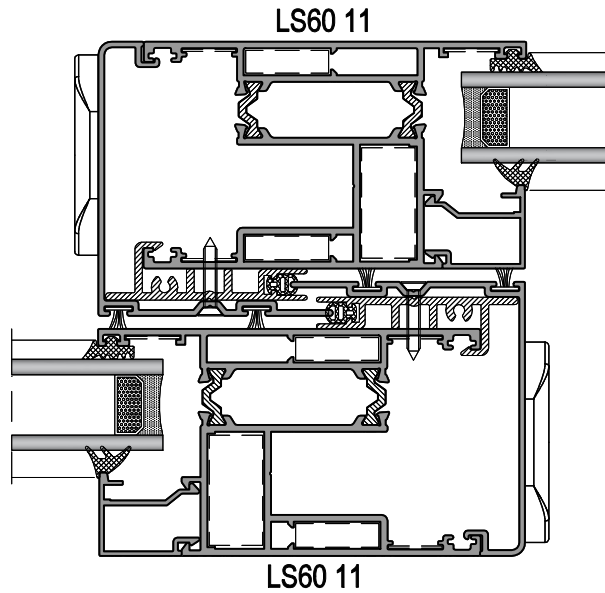
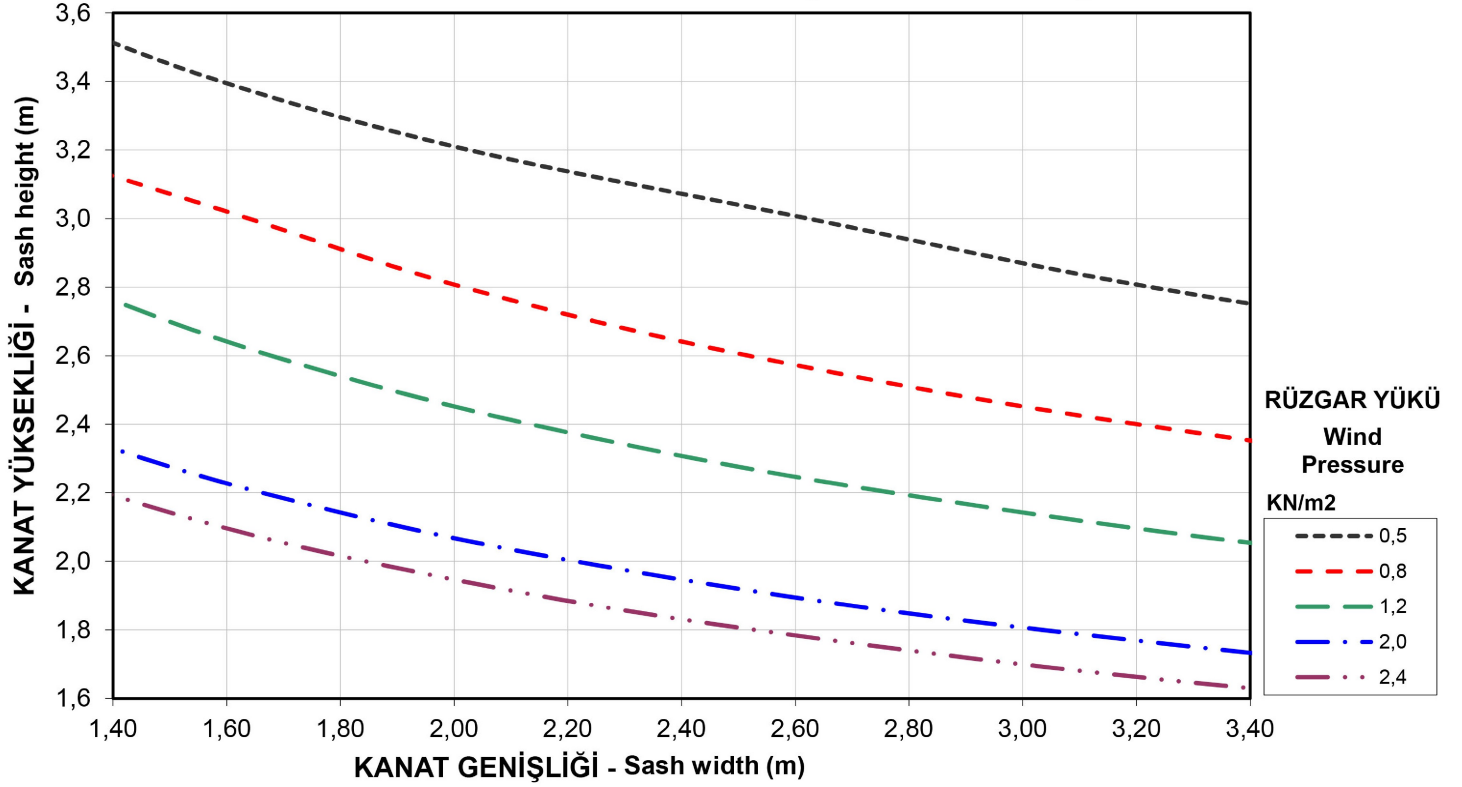
RÜZGAR YÜKÜNE GÖRE MAKSİMUM KANAT EBATLARI
MAXIMUM SASH DIMENSIONS FOR GIVEN WIND PRESSURE

KANAT EBATLARI BELİRLENİRKEN MEKANİZMANIN TAŞIMA KAPASİTESİNİ GEÇMEMESİNE DİKKAT EDİLMELİDİR
WHILE THE SASH DIMENSIONS DETERMINED, SASH WEIGHT MUST BE LESS THAN ROLLER CARRY CAPACITY

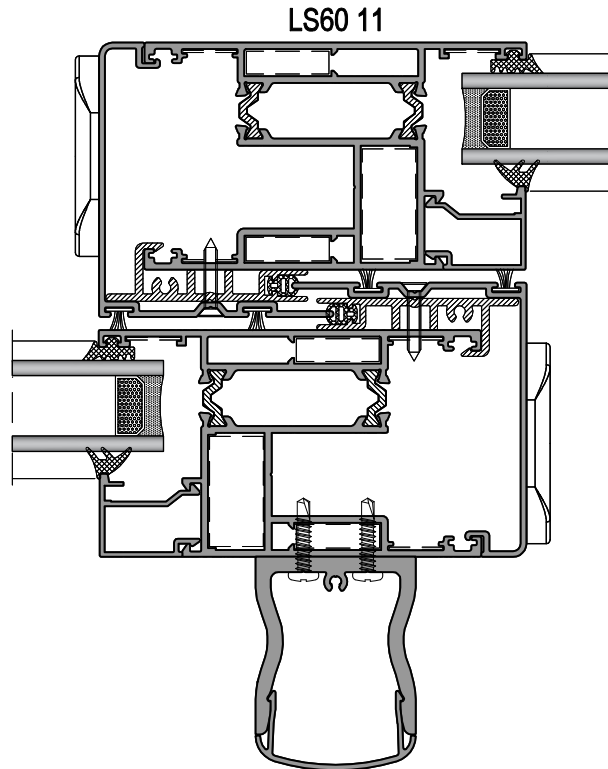
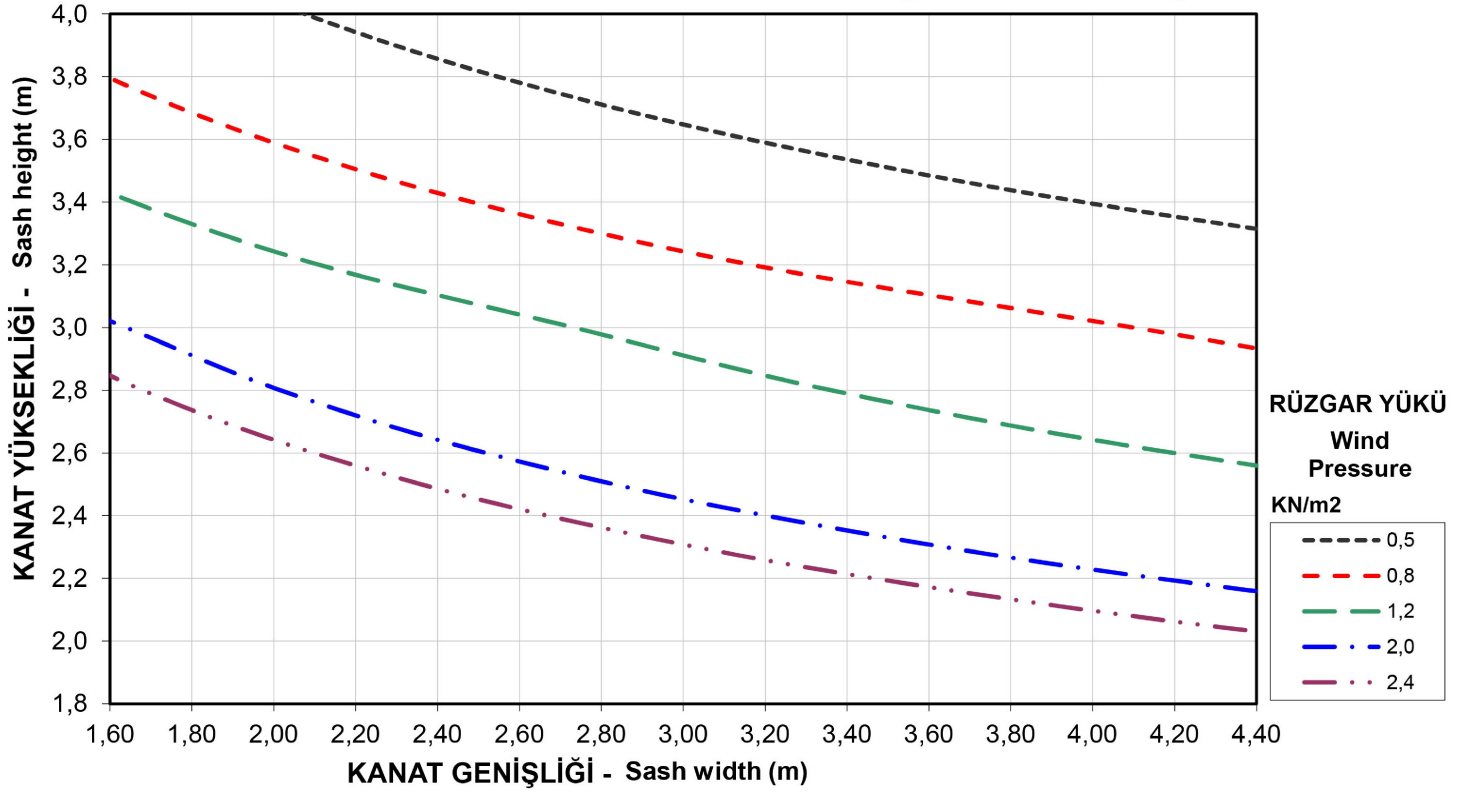
RÜZGAR YÜKÜNE GÖRE MAKSİMUM KANAT EBATLARI
MAXIMUM SASH DIMENSIONS FOR GIVEN WIND PRESSURE

KANAT EBATLARI BELİRLENİRKEN MEKANİZMANIN TAŞIMA KAPASİTESİNİ GEÇMEMESİNE DİKKAT EDİLMELİDİR
WHILE THE SASH DIMENSIONS DETERMINED, SASH WEIGHT MUST BE LESS THAN ROLLER CARRY CAPACITY

LS60 - 1,8mm

YALITIMLI KALDIR-SÜR SİSTEMİ
THERMAL LIFT&SLIDE SYSTEM

ASISTAL

SİSTEM DETAYLARI
SYSTEM DETAILS

LS60 - 1,8mm

YALITIMLI KALDIR-SÜR SİSTEM
THERMAL LIFT&SLIDE SYSTEM

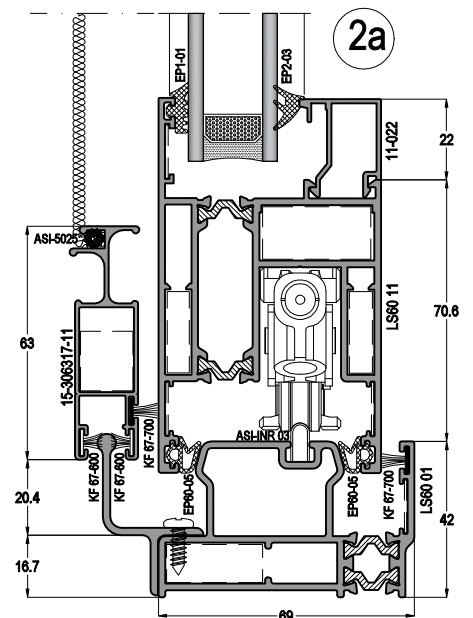
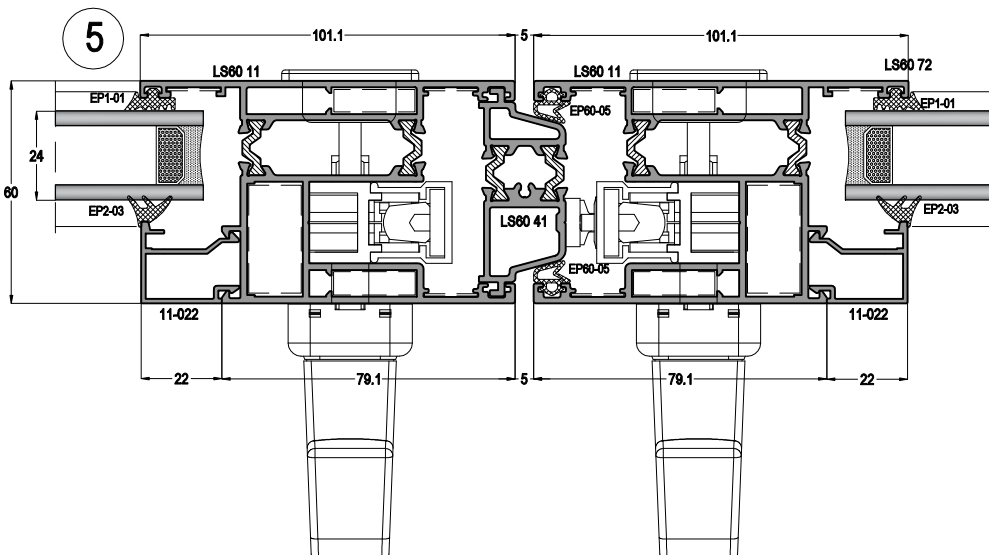
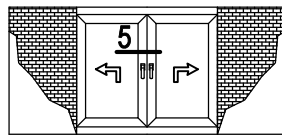
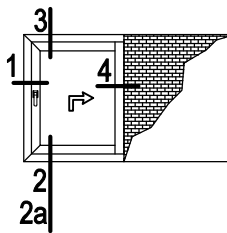
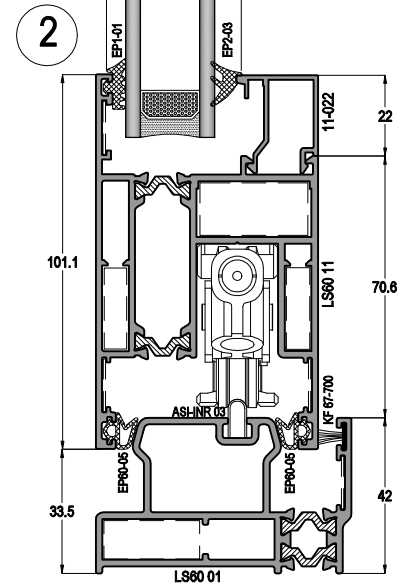
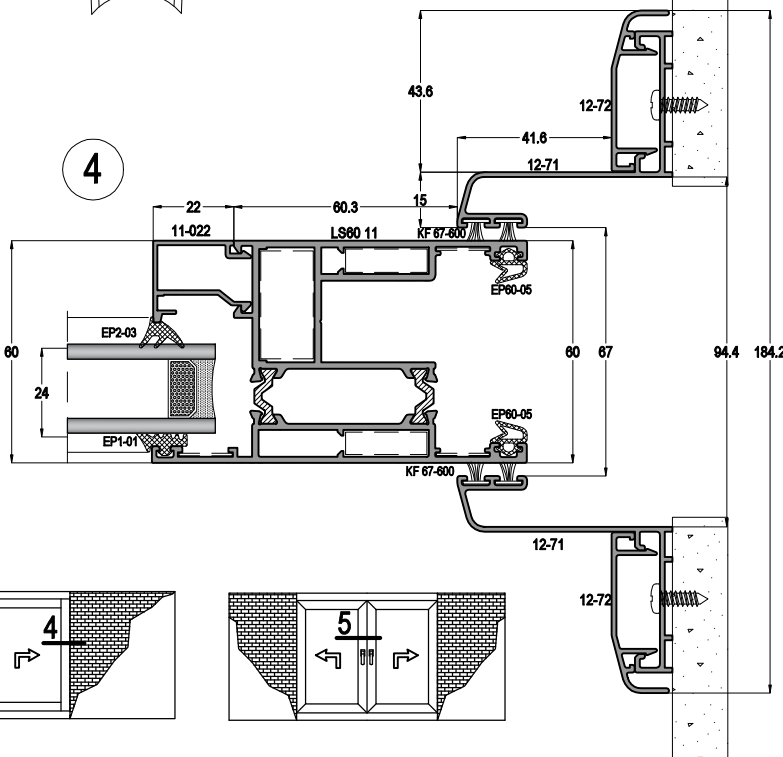
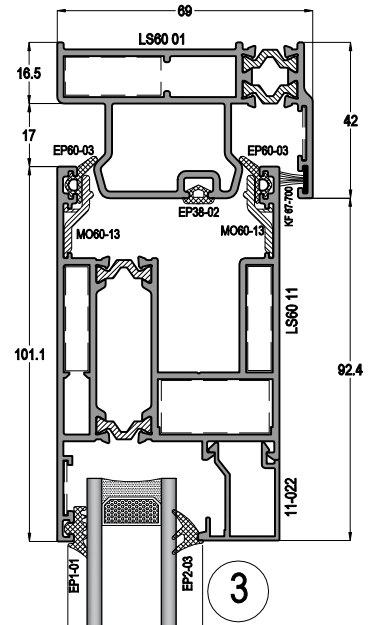
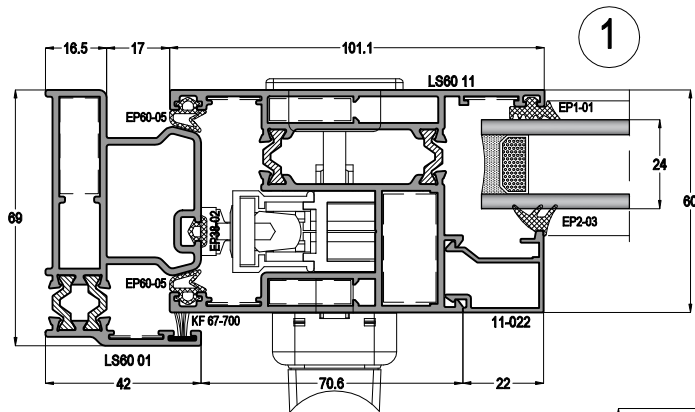

LS60 - 1,8mm

YALITIMLI KALDIR-SÜR SİSTEM
THERMAL LIFT&SLIDE SYSTEM

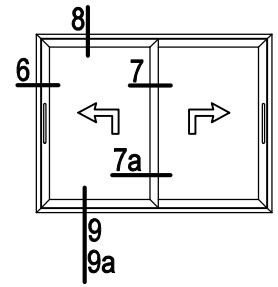

6

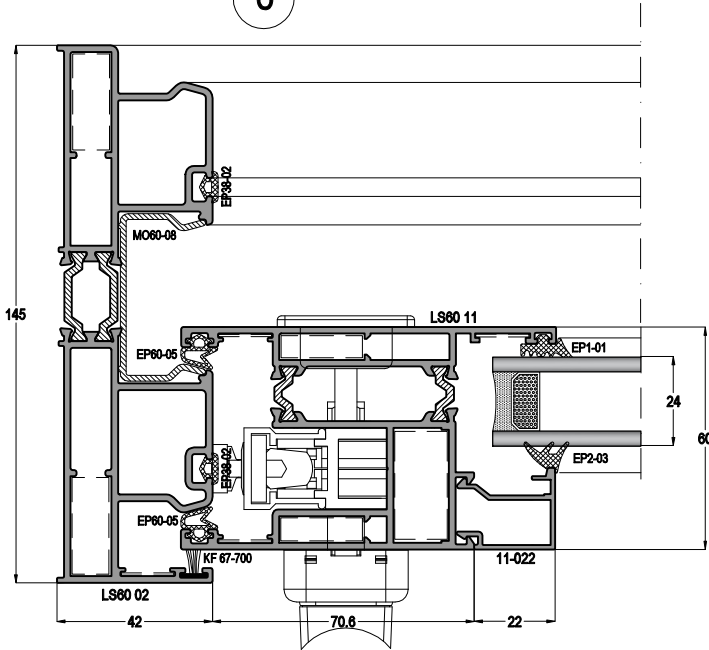

8

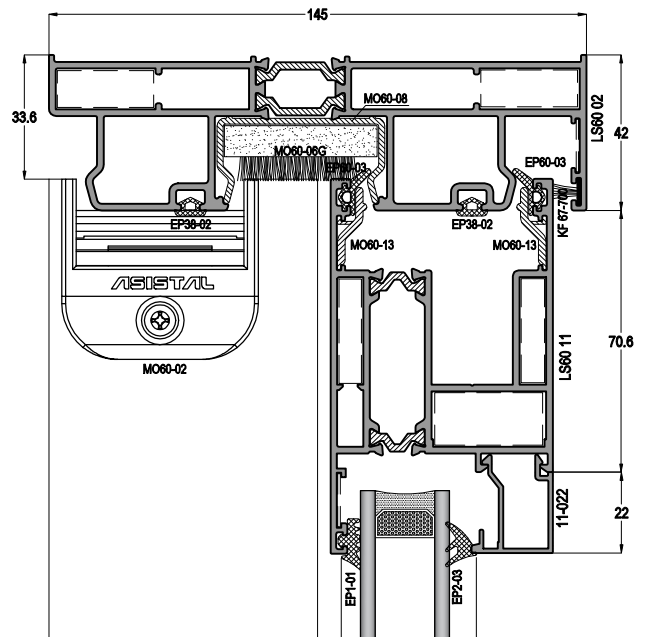

9a

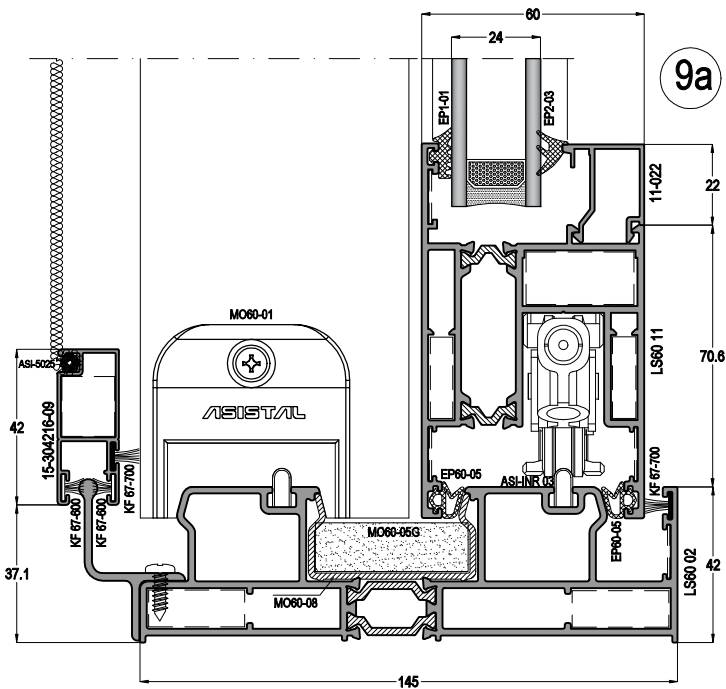

9

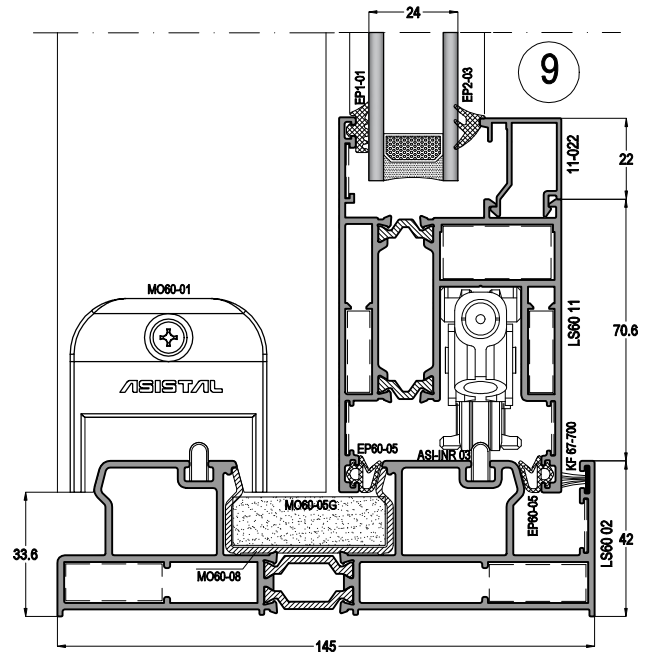

LS60 - 1,8mm

YALITIMLI KALDIR-SÜR SİSTEM
THERMAL LIFT&SLIDE SYSTEM

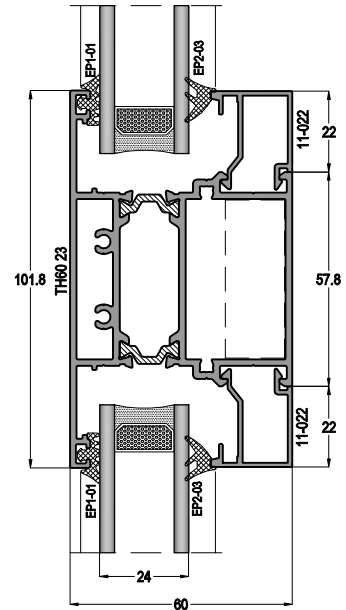
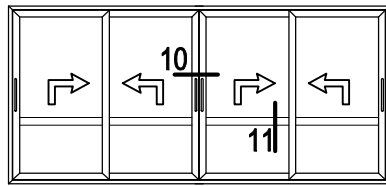
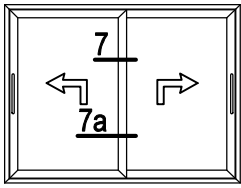

11

7

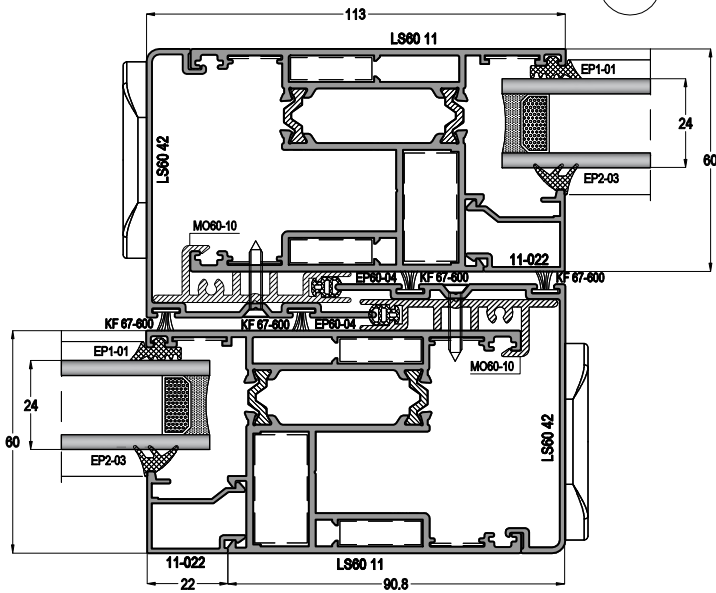

7a

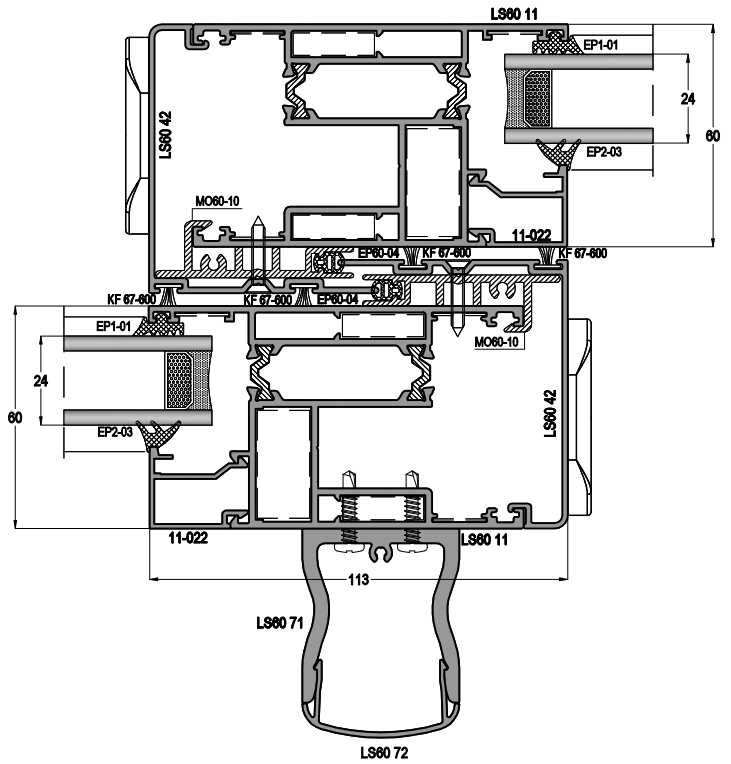

10

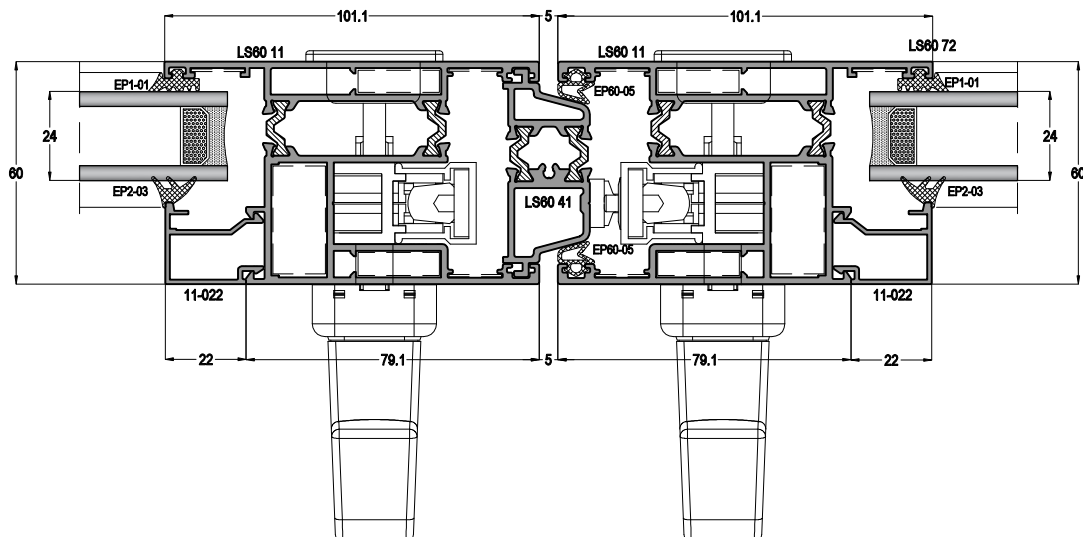

LS60 - 1,8mm

YALITIMLI KALDIR-SÜR SİSTEM
THERMAL LIFT&SLIDE SYSTEM



13

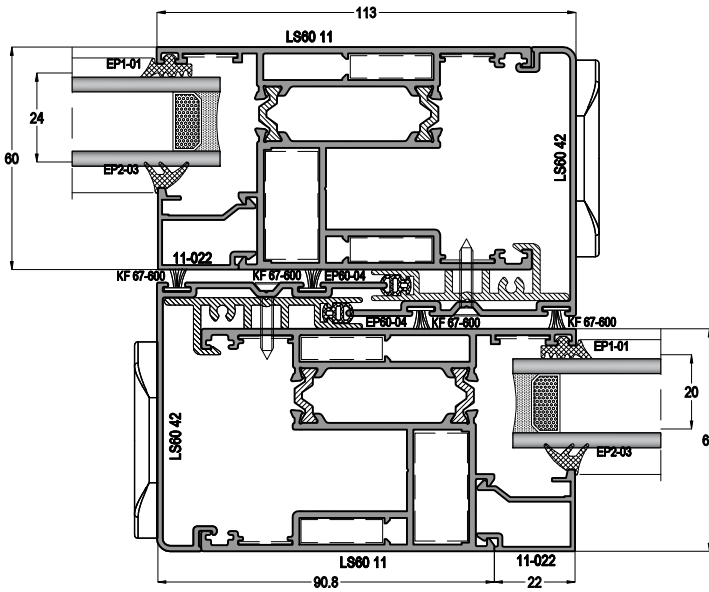

14

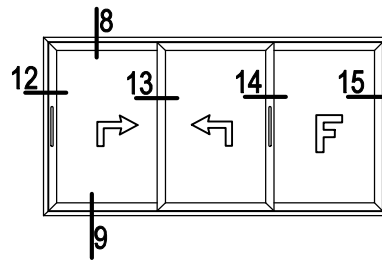
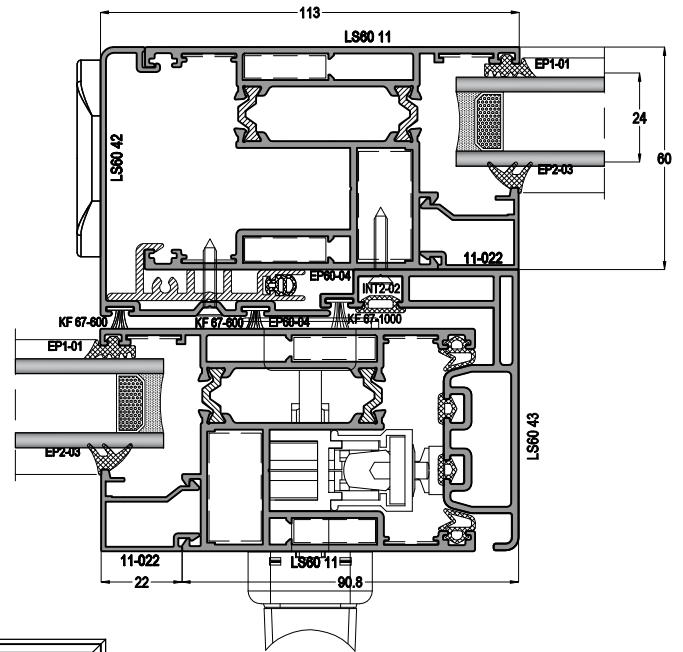

12

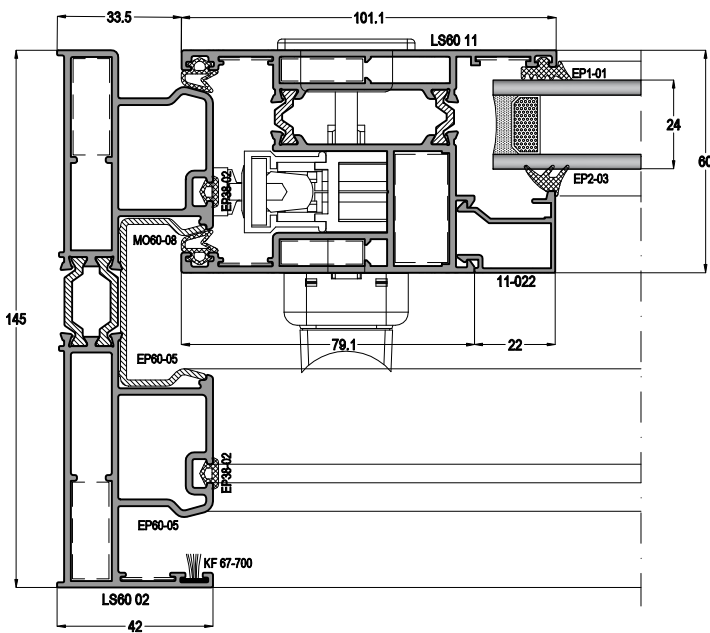

15

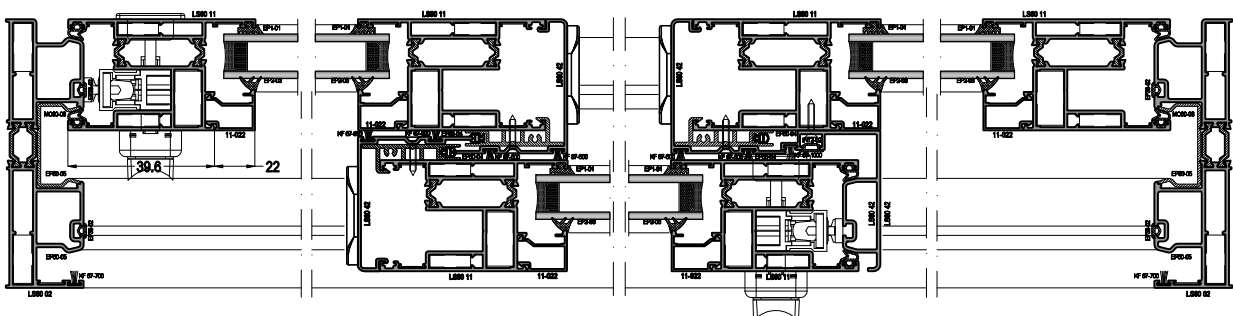
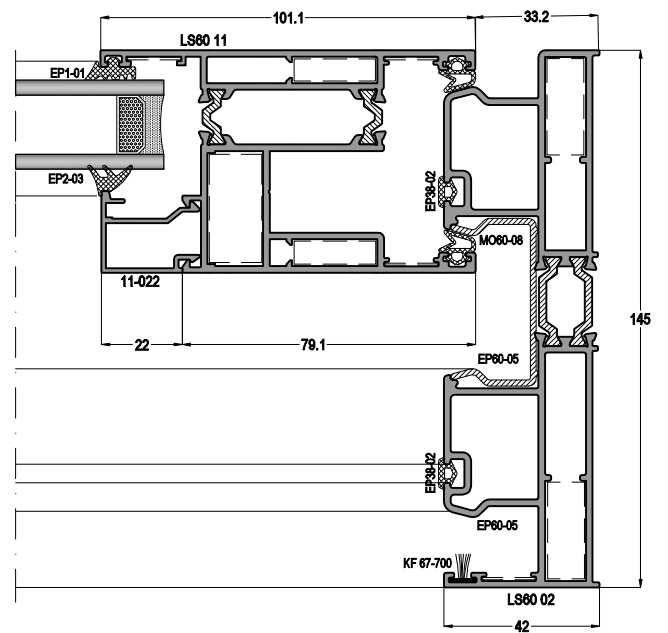

LS60 - 1,8mm

YALITIMLI KALDIR-SÜR SİSTEM
THERMAL LIFT&SLIDE SYSTEM

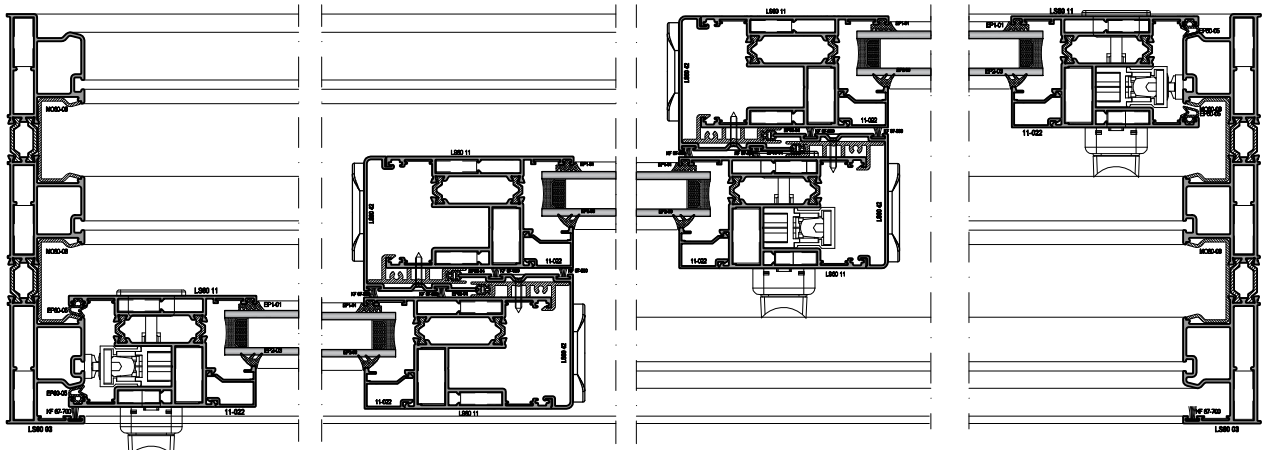
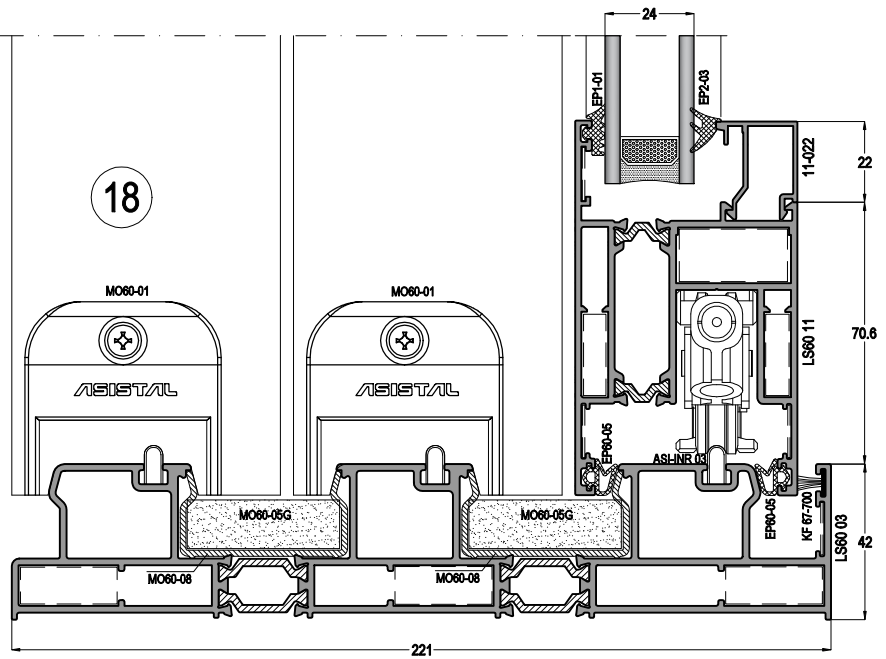
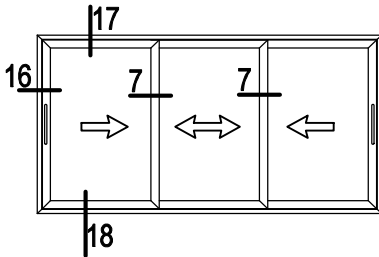
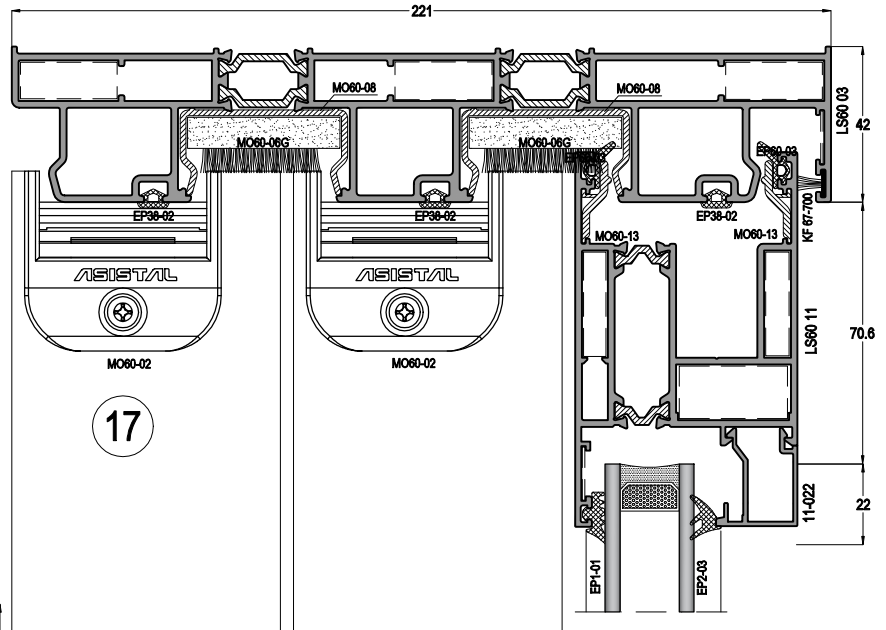
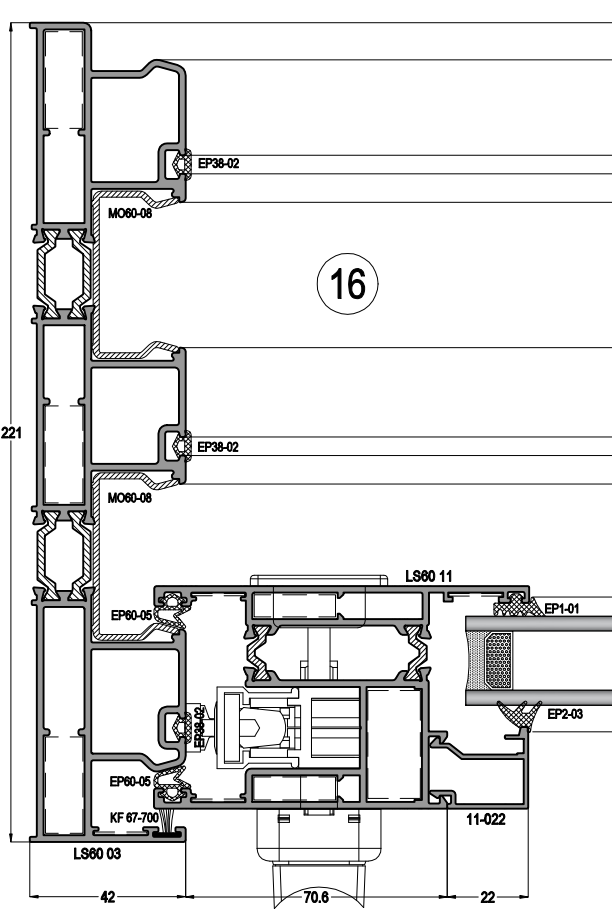

LS60 - 1,4mm

YALITIMLI KALDIR-SÜR SİSTEM
THERMAL LIFT&SLIDE SYSTEM

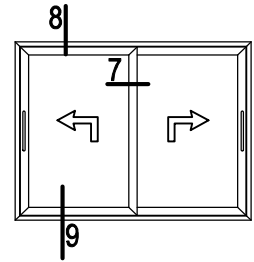
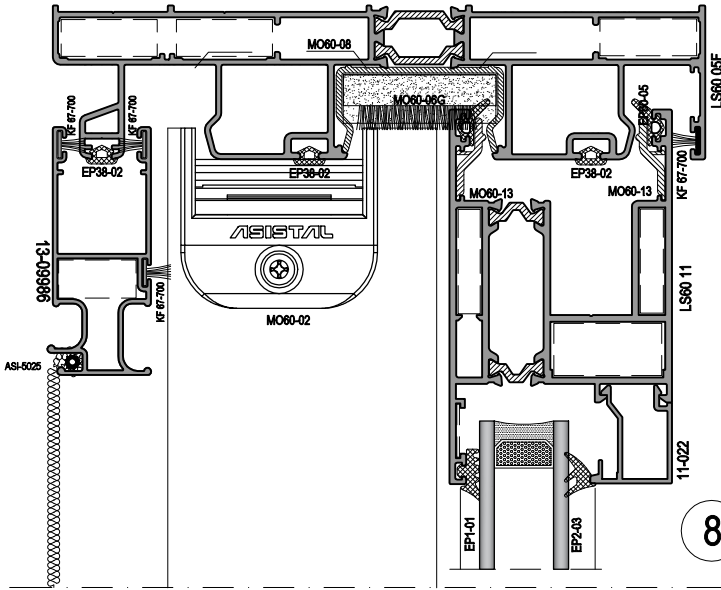

8

9

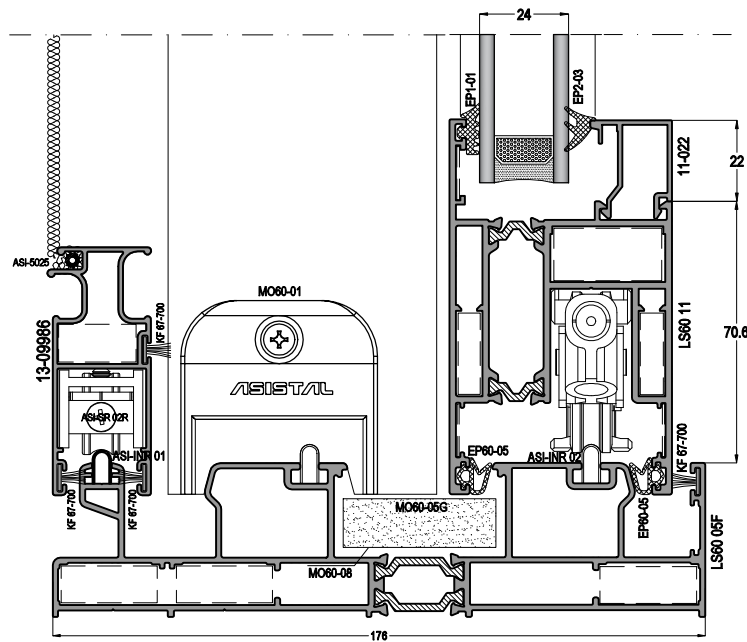

9

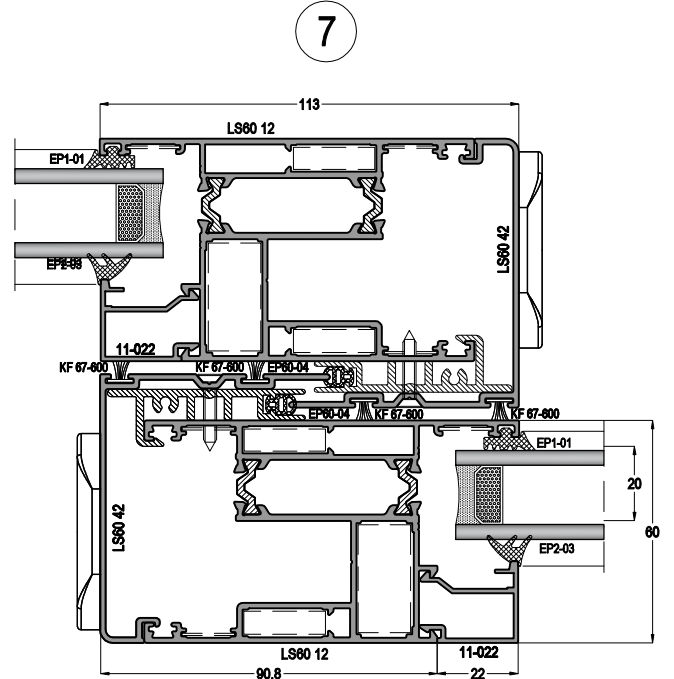

7

LS60 - 1,4mm

YALITIMLI KALDIR-SÜR SİSTEM
THERMAL LIFT&SLIDE SYSTEM

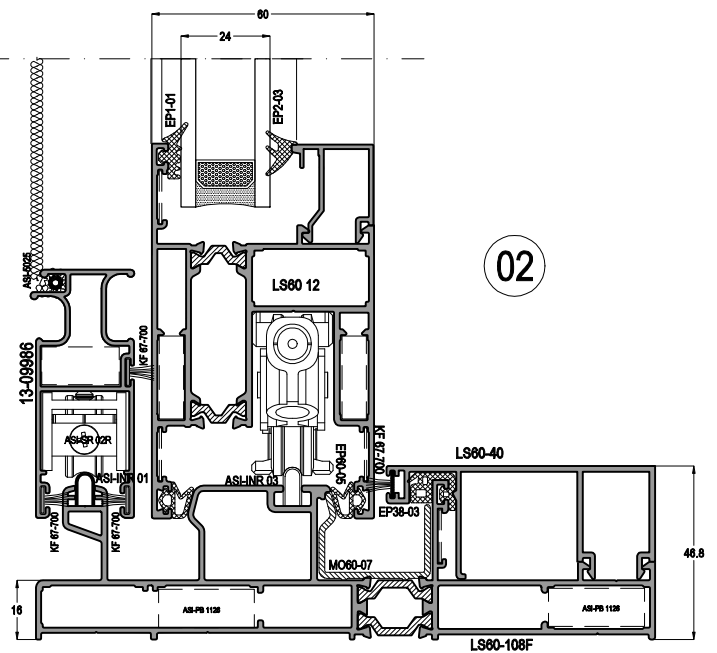
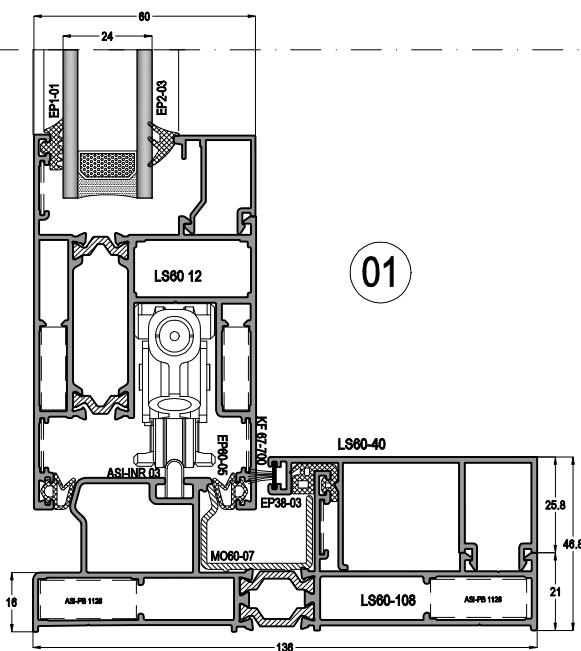
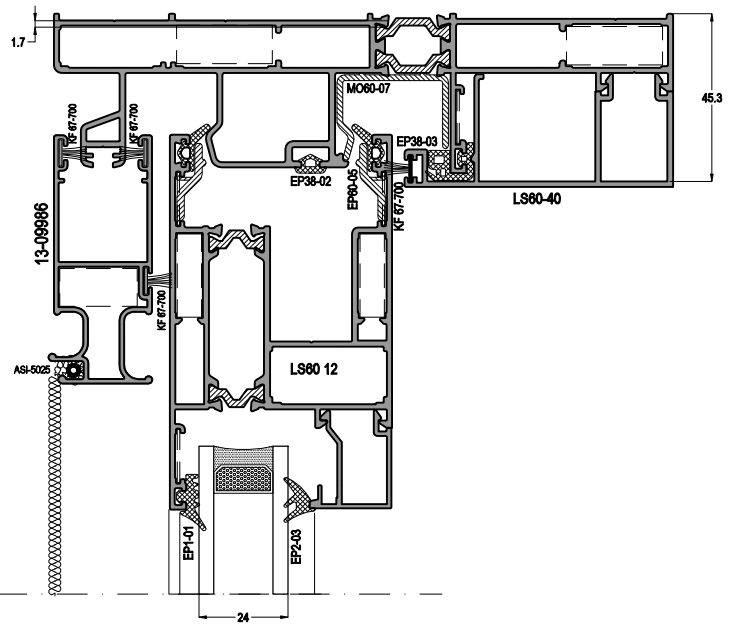
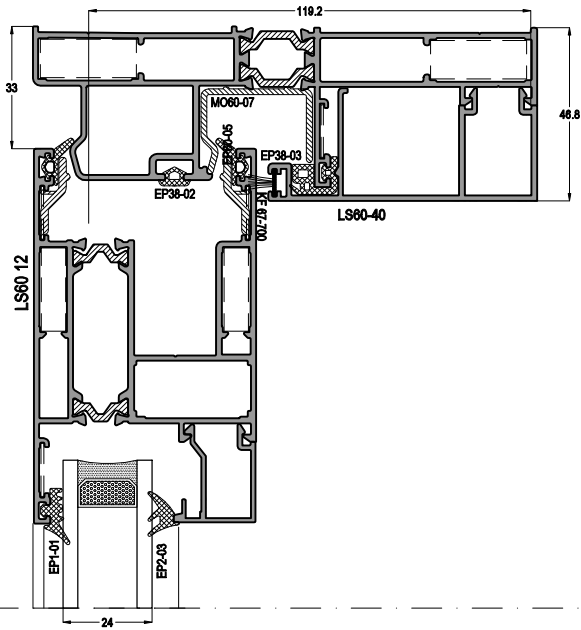
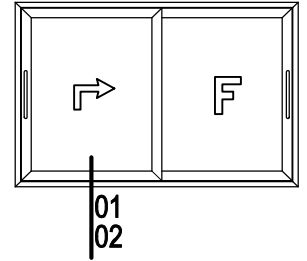

LS60

YALITIMLI KALDIR-SÜR SİSTEM
THERMAL LIFT&SLIDE SYSTEM

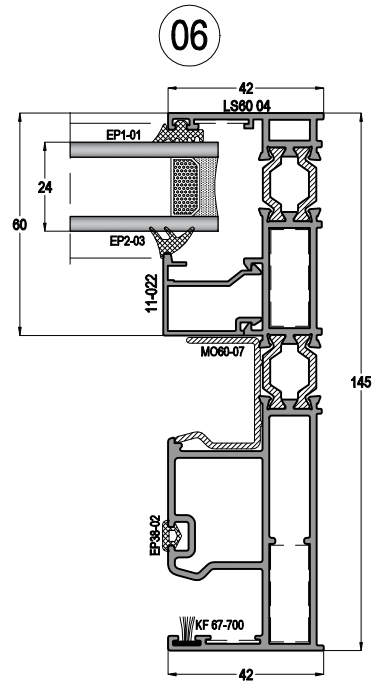
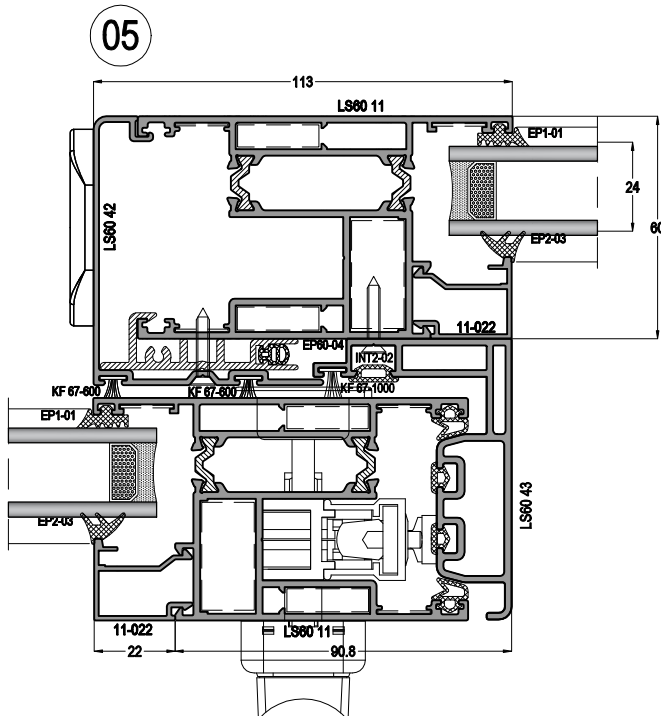
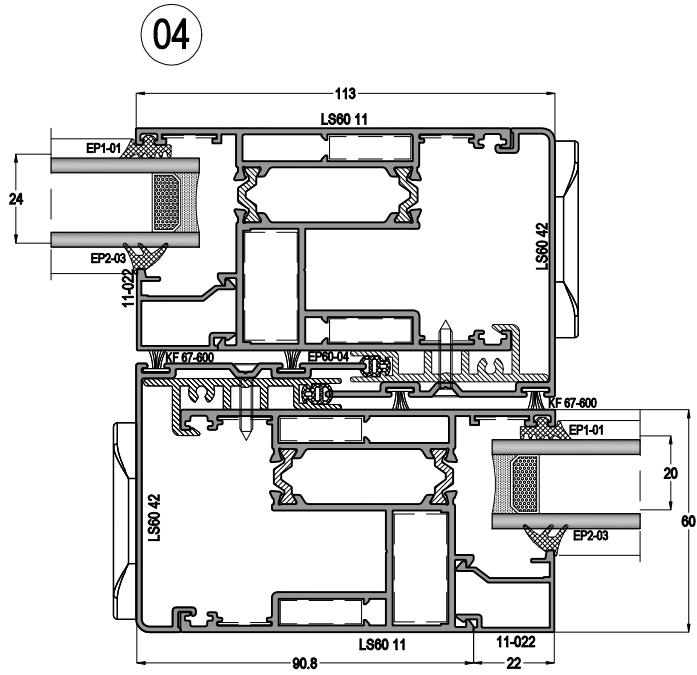
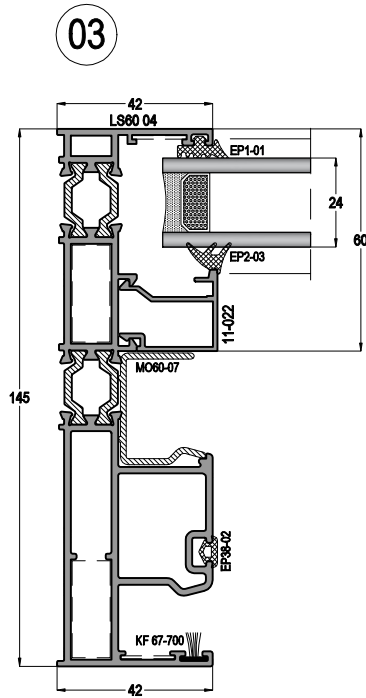
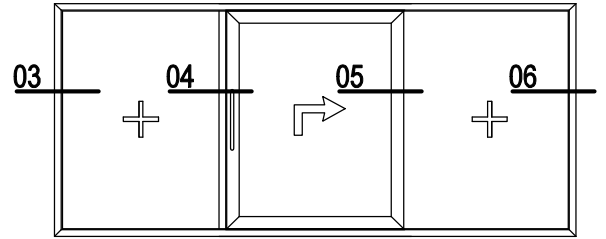

LS60

YALITIMLI KALDIR-SÜR SİSTEM
THERMAL LIFT&SLIDE SYSTEM



03

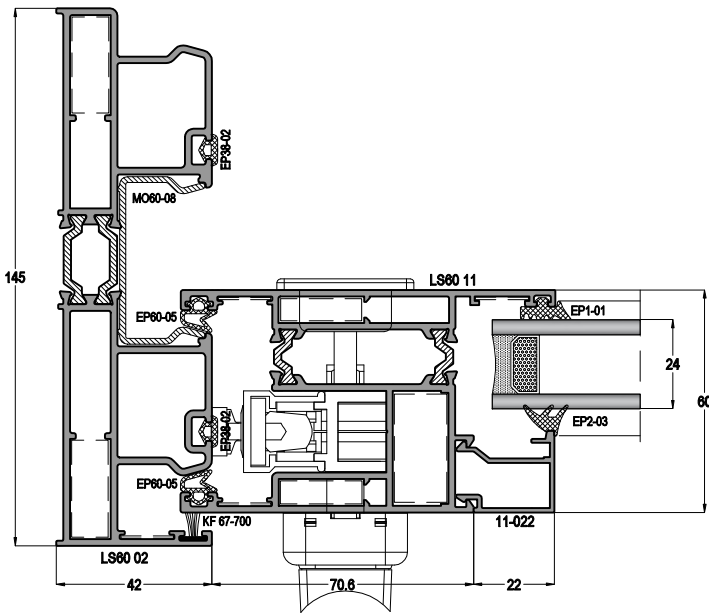

7

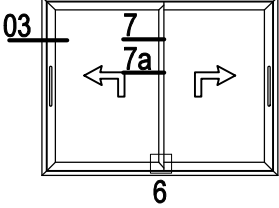
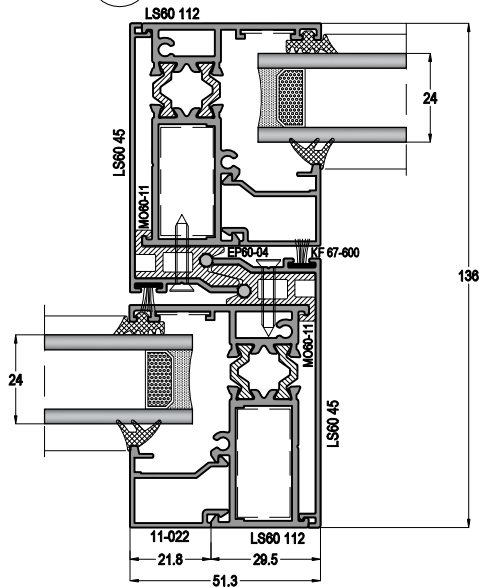

03

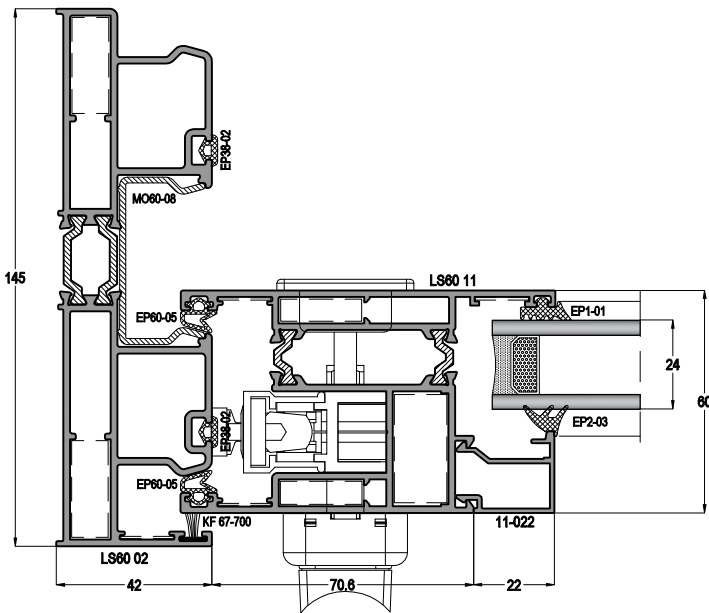

7a

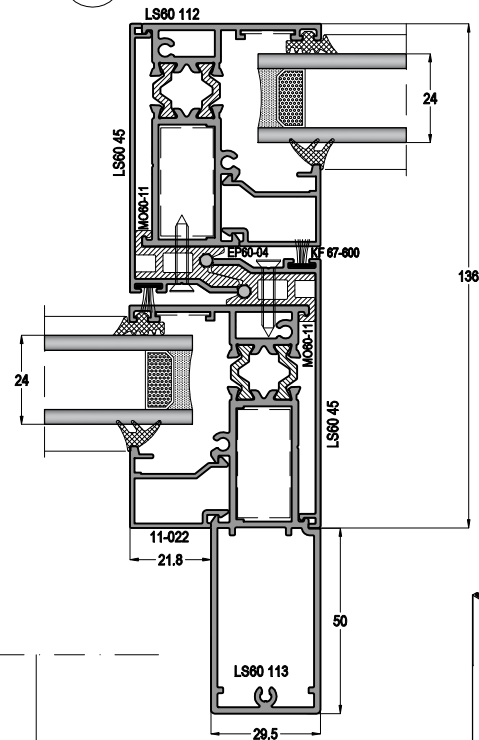

6

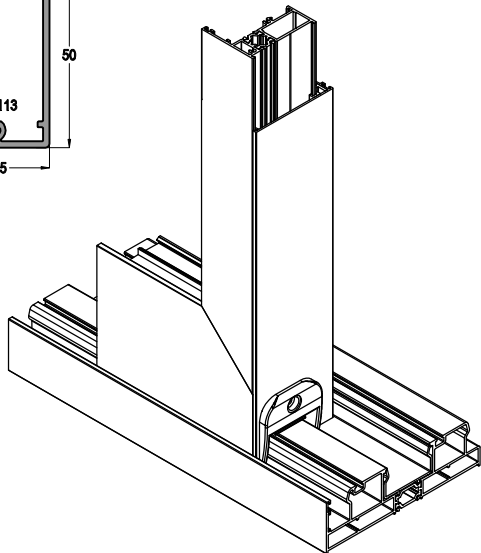
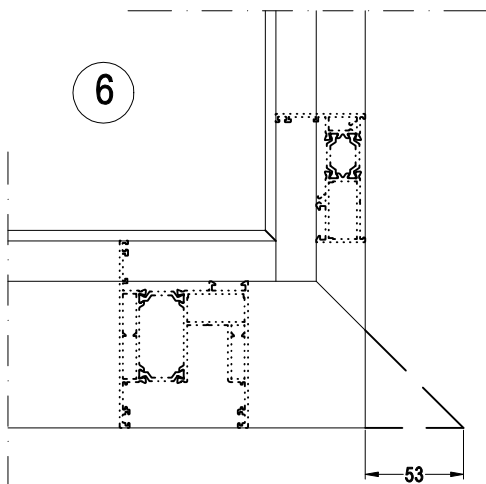



HAREKETLİ KANATDAN SABİT YAPILMASI
SLIDING SASH CONVERTING TO THE FIXED SASH

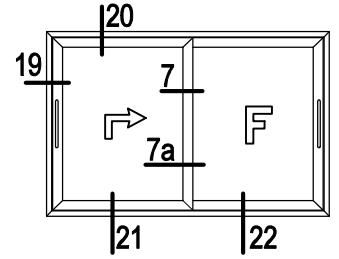

19

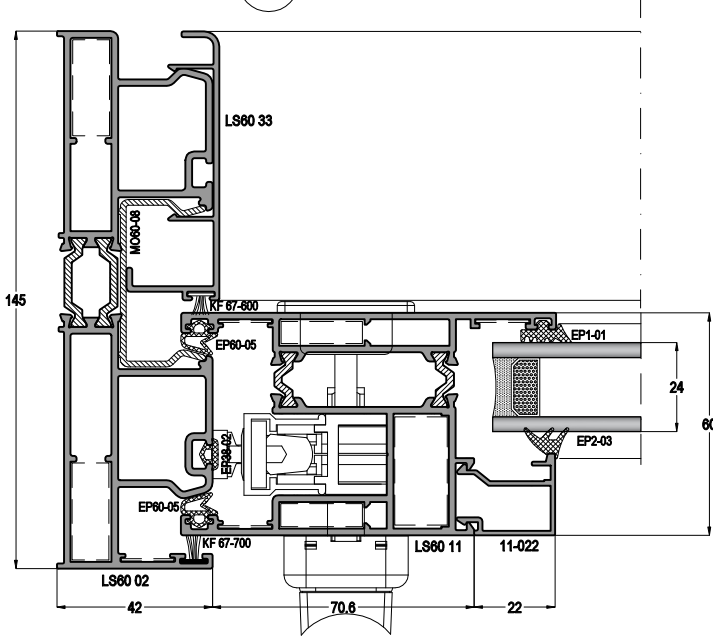

20

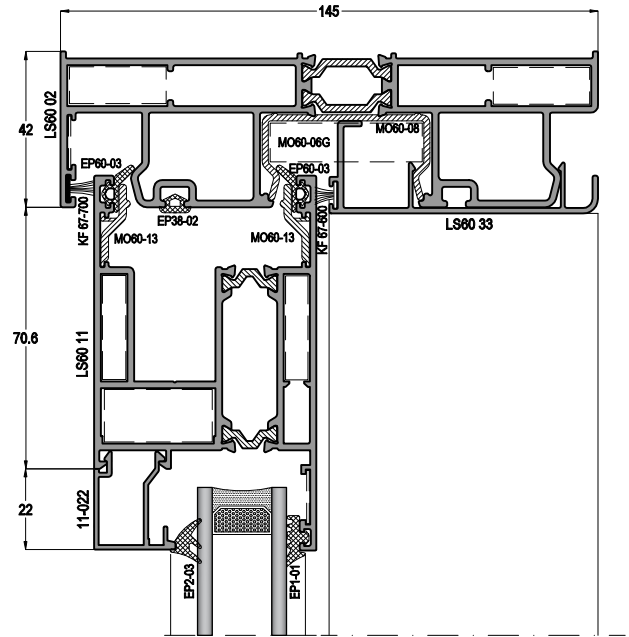

22

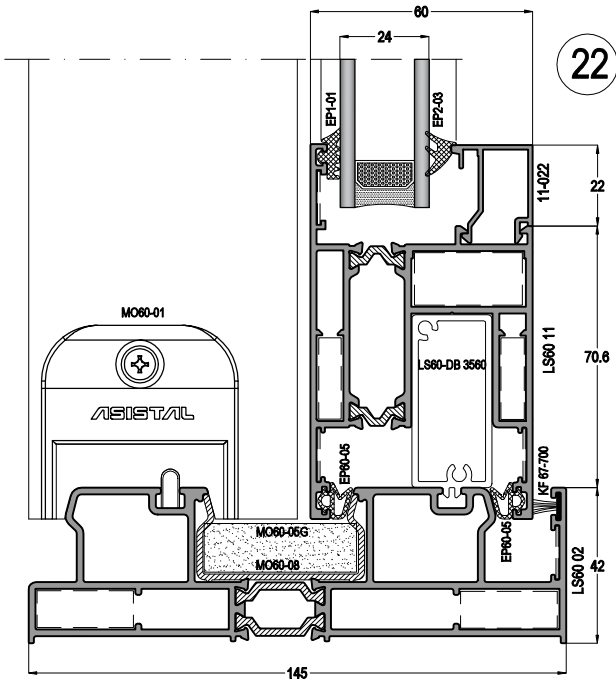

21

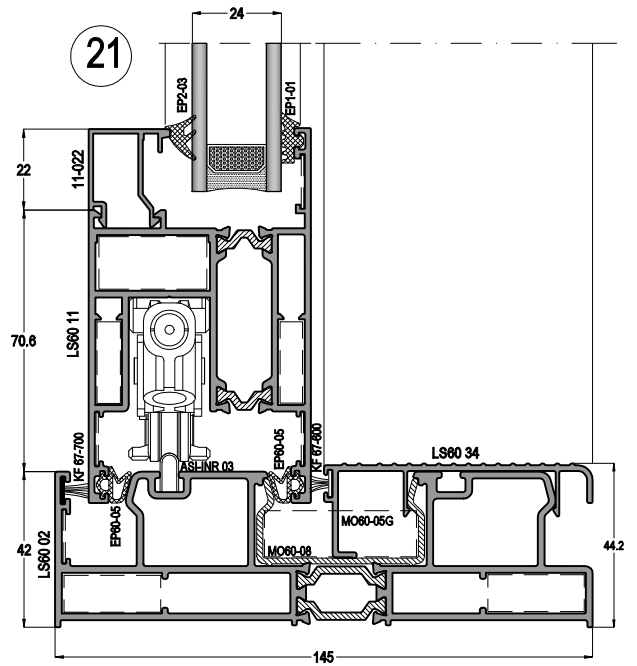

LS60

YALITIMLI KALDIR-SÜR SİSTEM
THERMAL LIFT&SLIDE SYSTEM

ASISTAL

HAREKETLİ KANADI İÇERİDE OLAN MONORAIL SİSTEM
MONORAIL SYSTEM WITH SLIDING SASH INSIDE

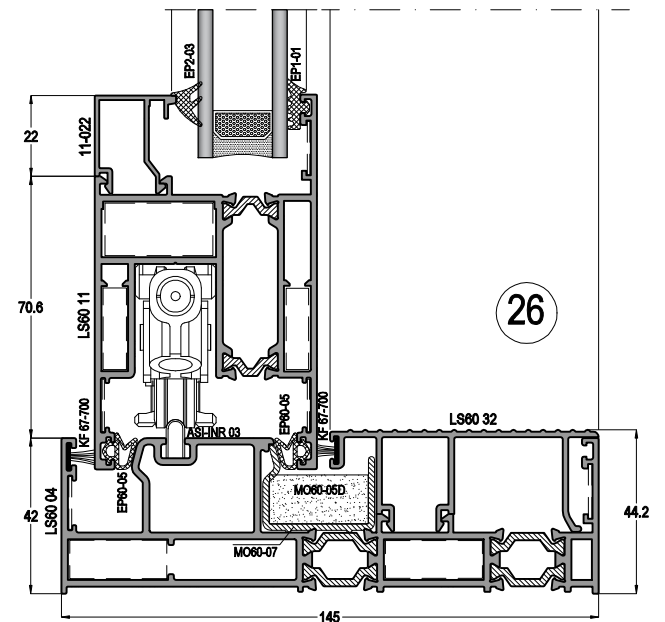
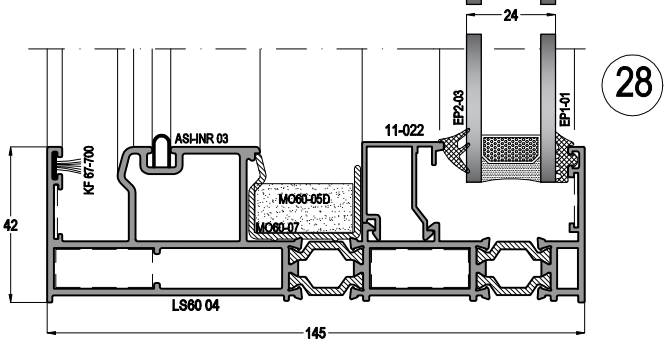
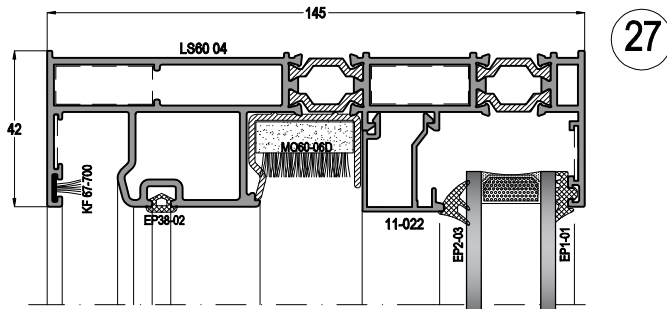
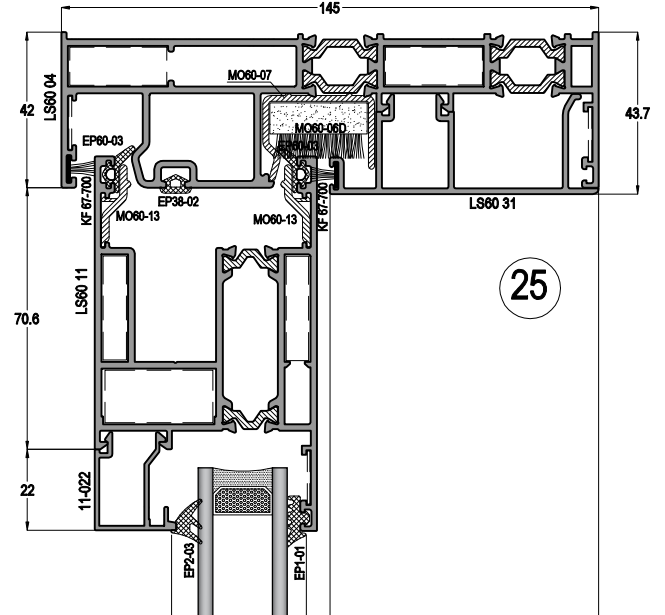
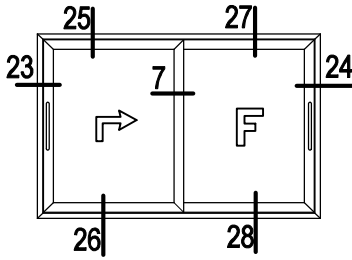
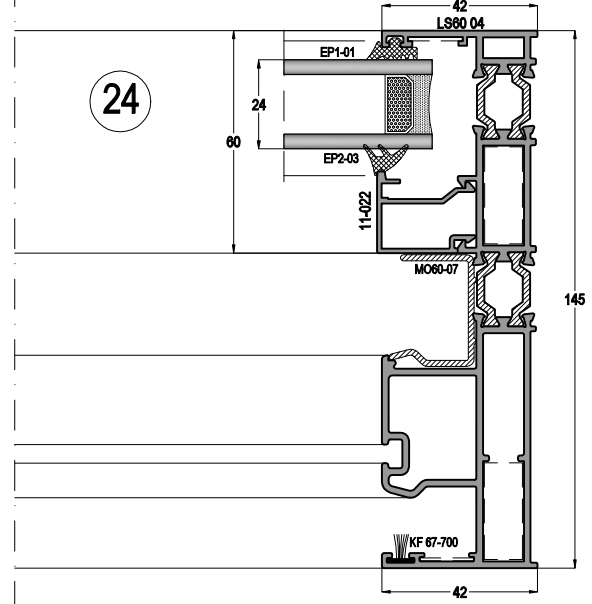
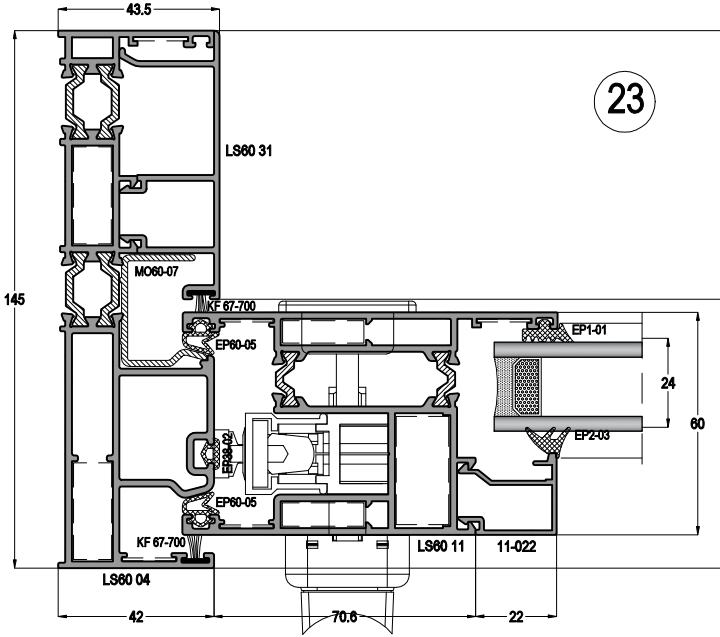

LS60

YALITIMLI KALDIR-SÜR SİSTEM
THERMAL LIFT&SLIDE SYSTEM

ASISTAL

HAREKETLİ KANADI DIŞARIDA OLAN MONORAIL SİSTEM
MONORAIL SYSTEM WITH SLIDING SASH OUTSIDE

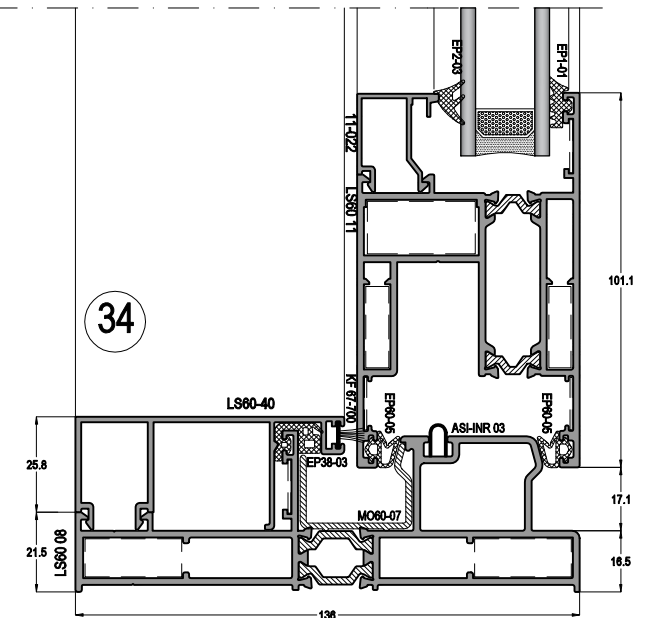
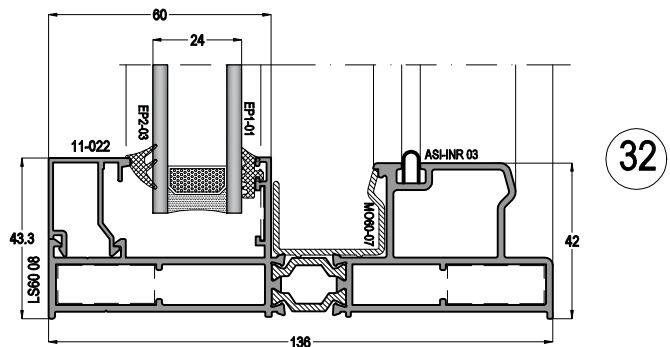
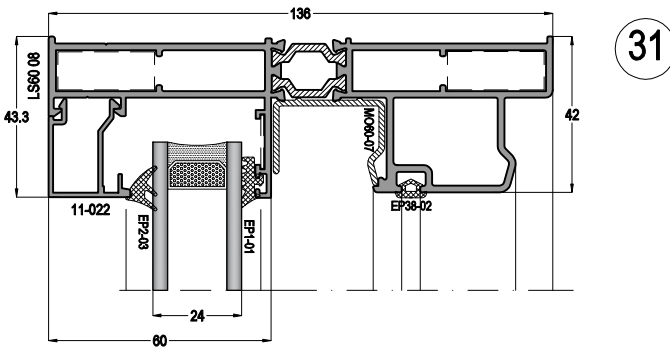
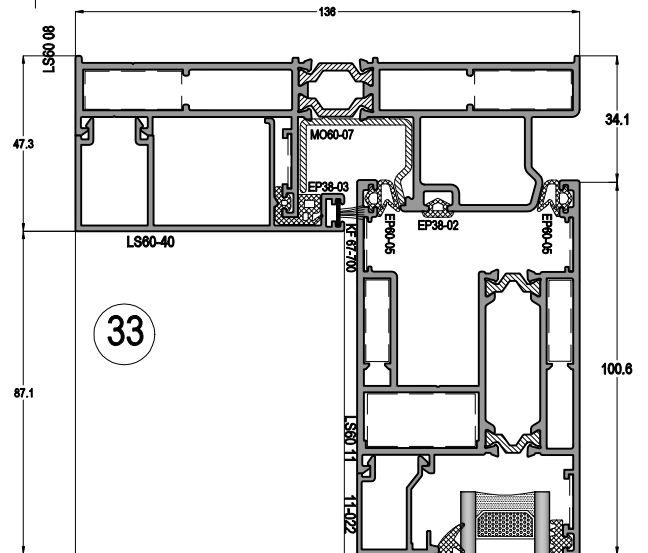
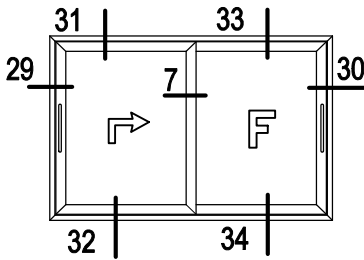
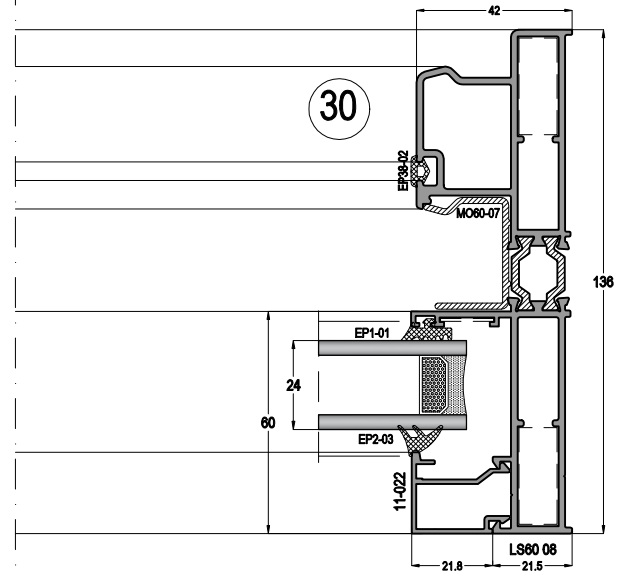
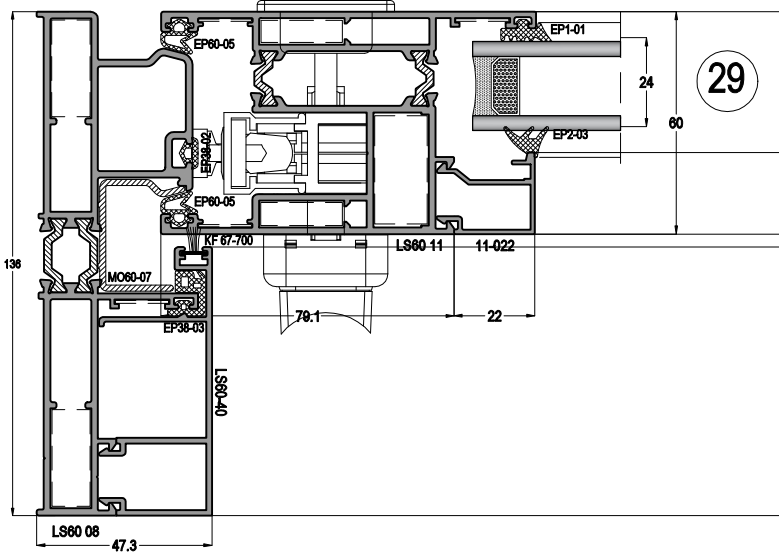

ö: 1/2

LS60

YALITIMLI KALDIR-SÜR SİSTEM
THERMAL LIFT&SLIDE SYSTEM

ASISTAL

TH62 SİSTEME GEÇİŞ KASASI
TRANSITION FRAME TO TH62 SYSTEM

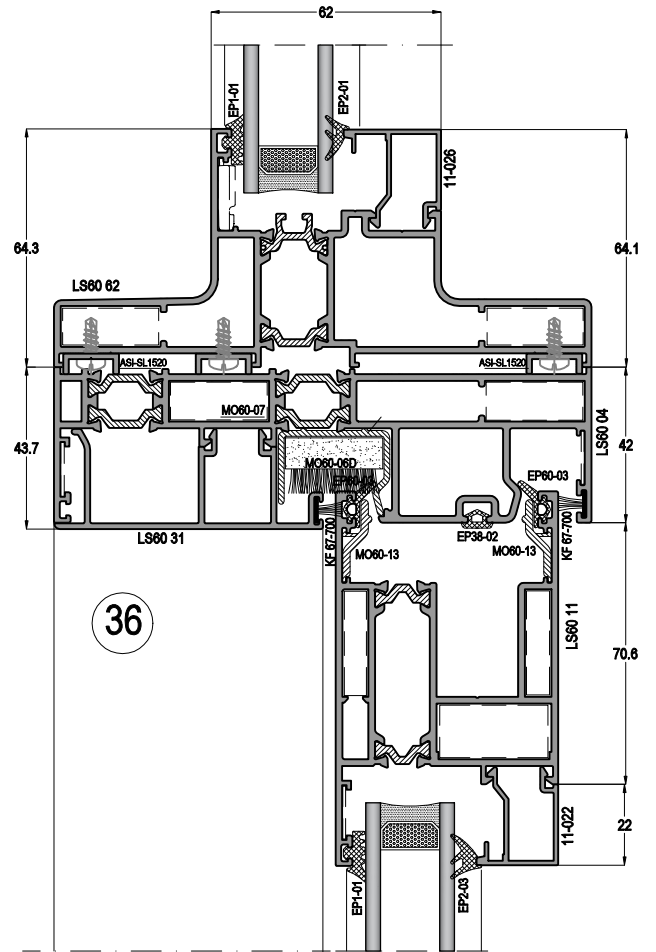
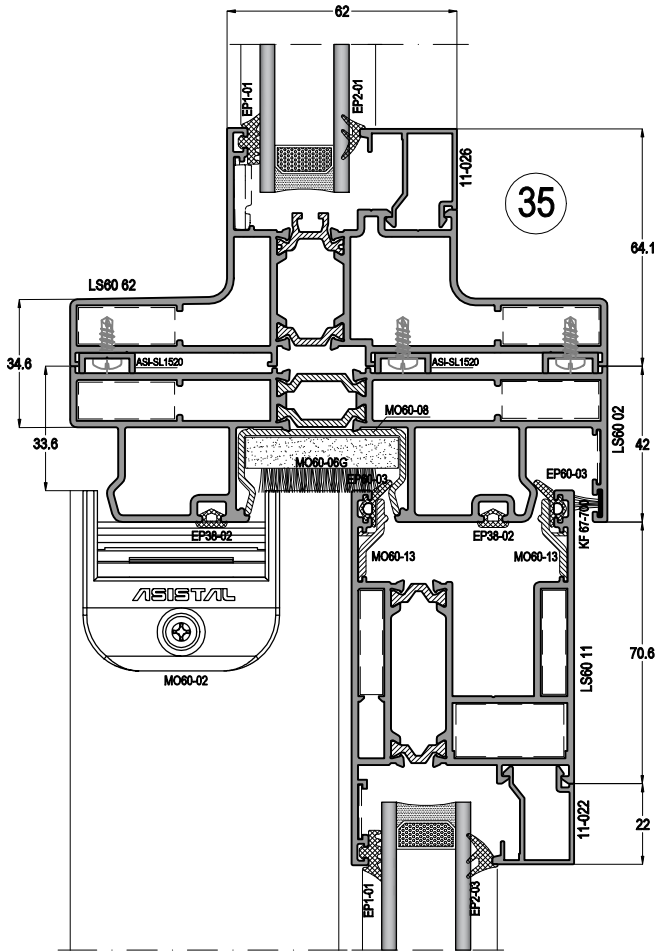
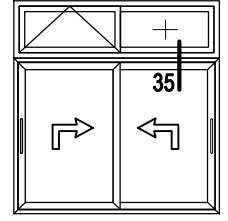
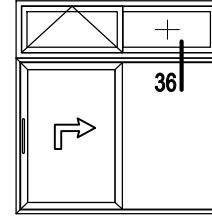

LS60

YALITIMLI KALDIR-SÜR SİSTEM
THERMAL LIFT&SLIDE SYSTEM



NORMAL SÜRME SİSTEM DETAYI - LS60 N NORMAL SLIDING SYSTEM DETAILS

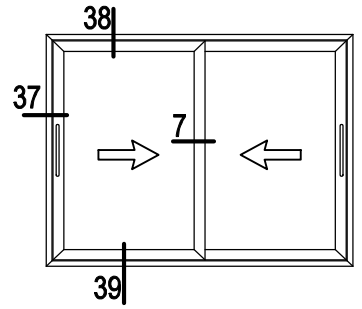

37

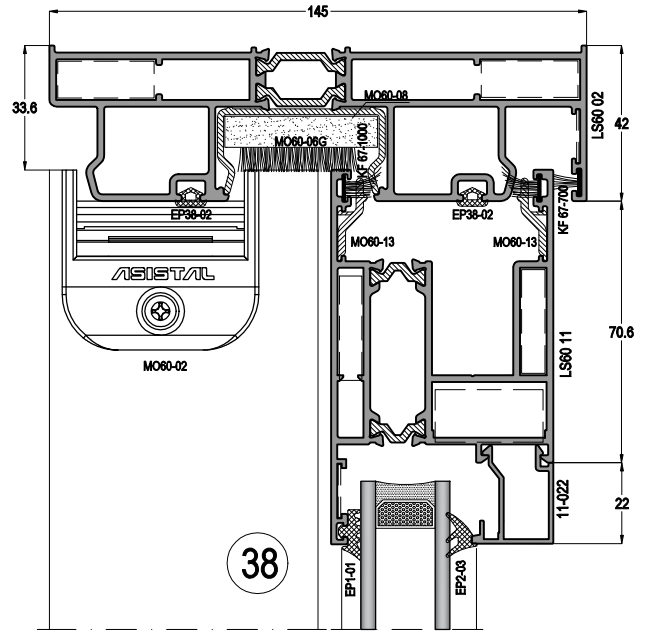
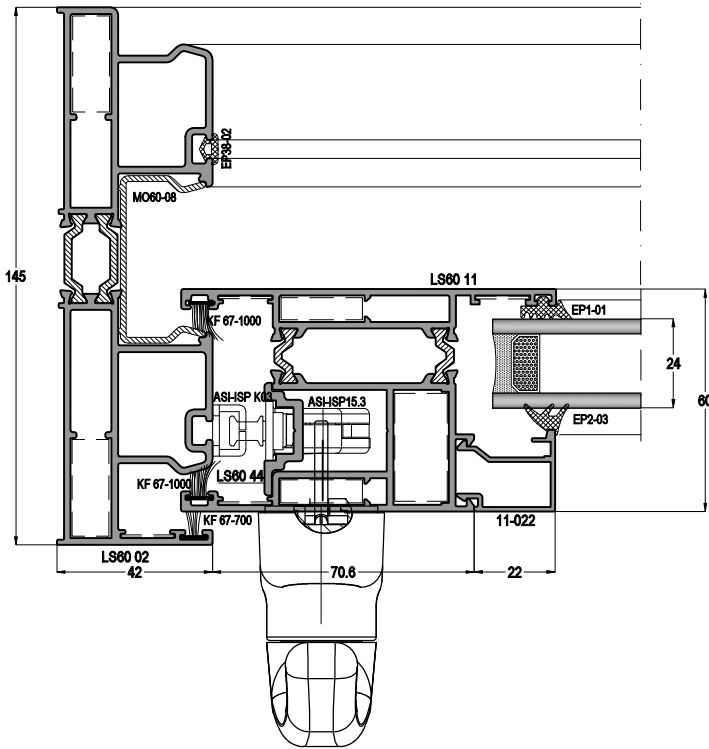

38

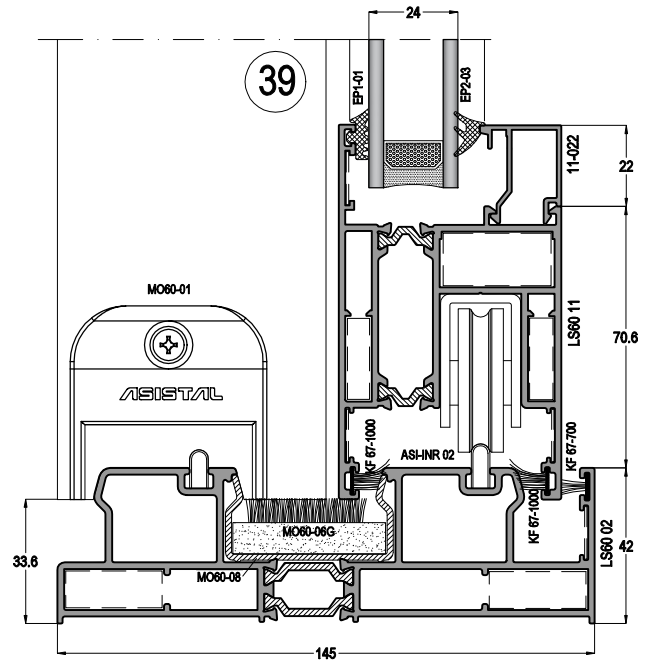

39